

NOM .....

DATE .....Total Score.....

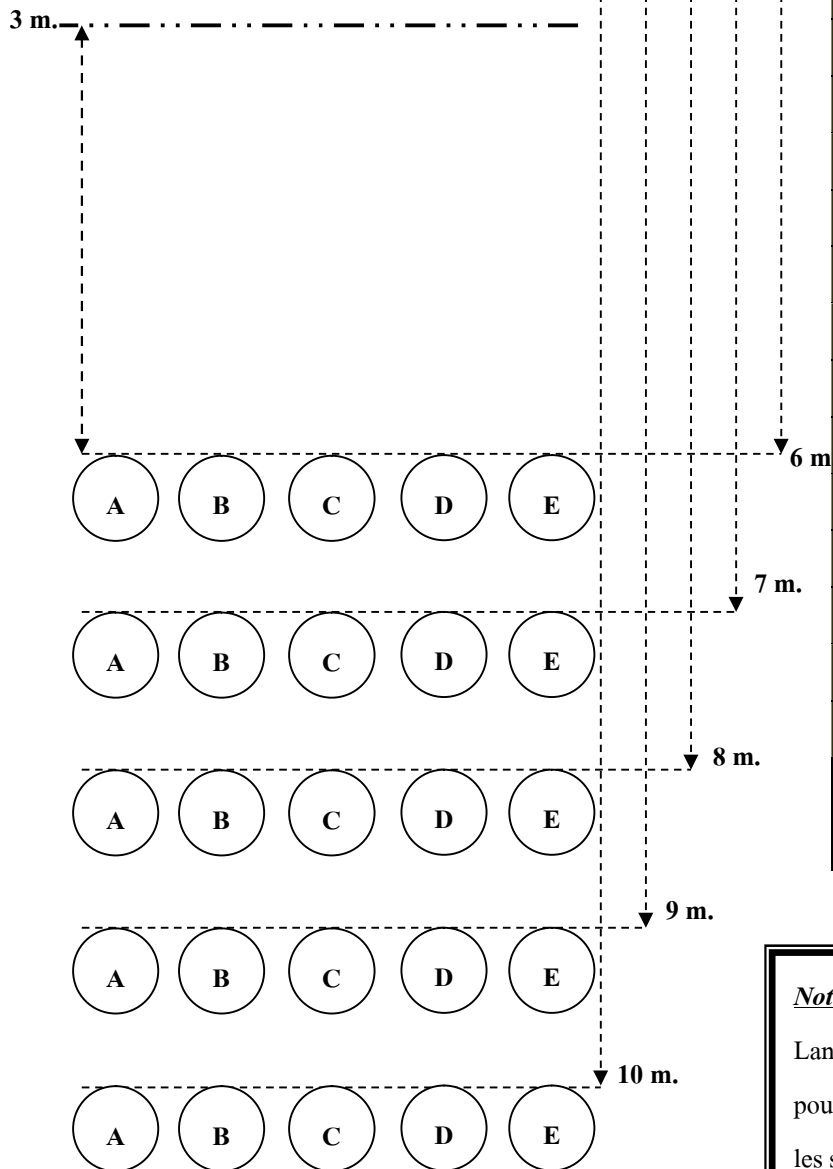

stance	No.	Score Station				
		A	B	C	D	E
6 m.	1					
	2					
	3					
7 m.	1					
	2					
	3					
8 m.	1					
	2					
	3					
9 m.	1					
	2					
	3					
10 m.	1					
	2					
	3					
Total Score						

**Note Demie portee**  
 Lancer la boule au-delà de la ligne (3 mètres du cercle) pour finir à l'intérieur du cercle jaune, utilisant toutes les stations et distances.  
 .....  
 .....

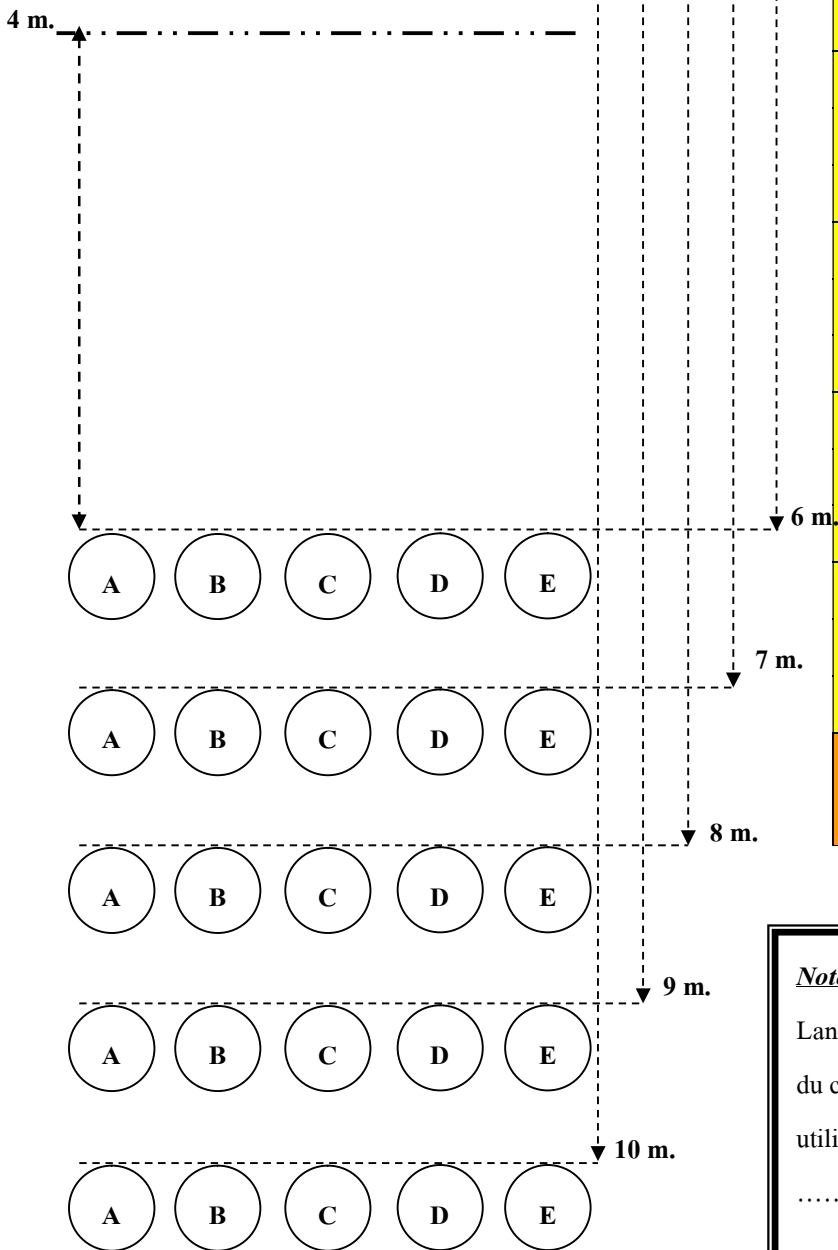
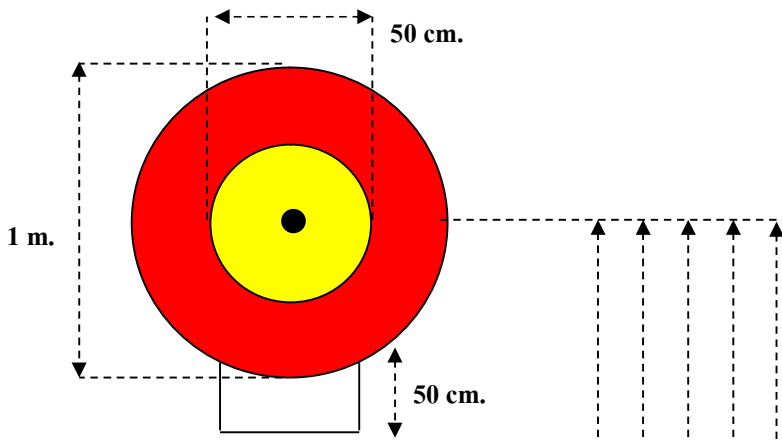

NOM .....

DATE ..... Total Score.....

Distance	No.	Score Station				
		A	B	C	D	E
6 m.	1					
	2					
	3					
7 m.	1					
	2					
	3					
8 m.	1					
	2					
	3					
9 m.	1					
	2					
	3					
10 m.	1					
	2					
	3					
Total Score						

**Note LOBER**  
 Lancer la boule au-delà de la ligne à 4 mètres à partir du cercle pour finir à l'intérieur du cercle jaune, utilisant toutes les stations et distances.  
 .....  
 .....

NOM .....

DATE ..... Total Score.....

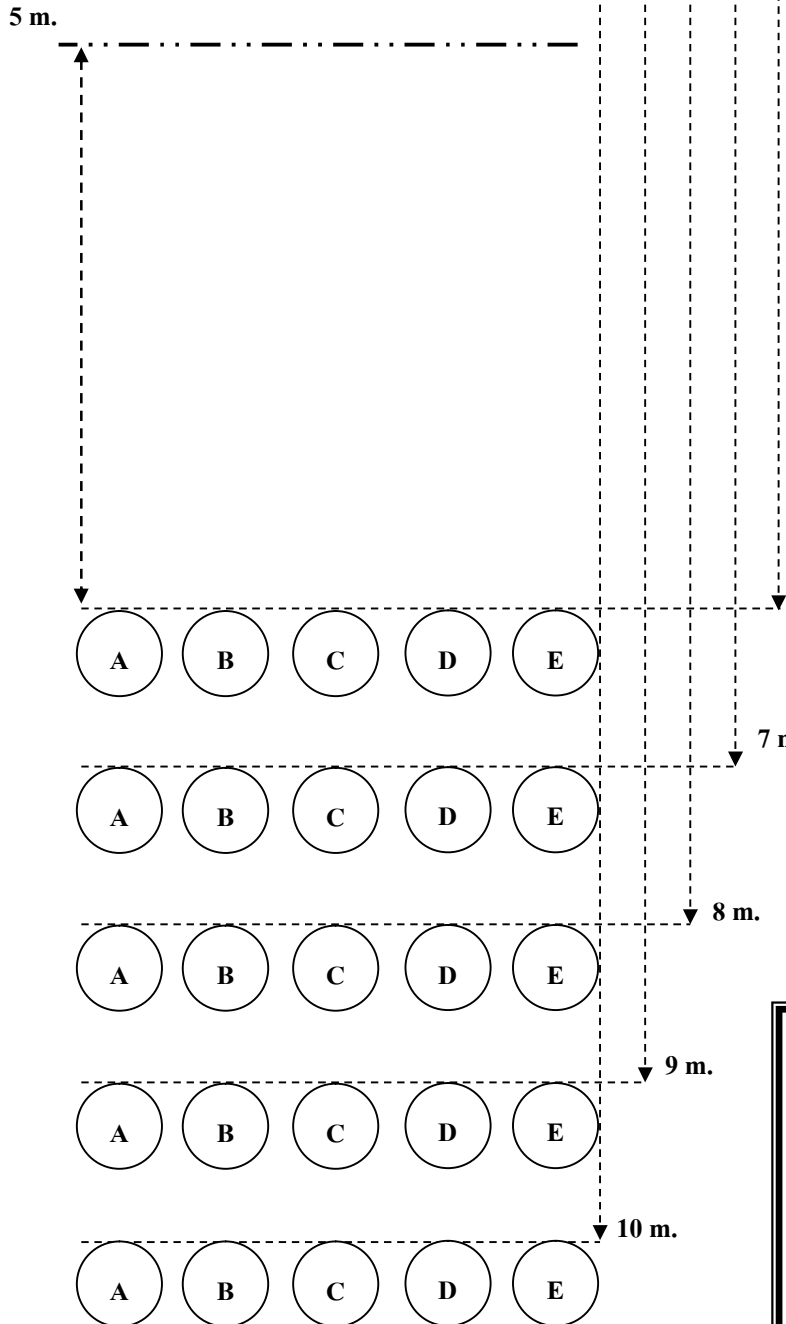
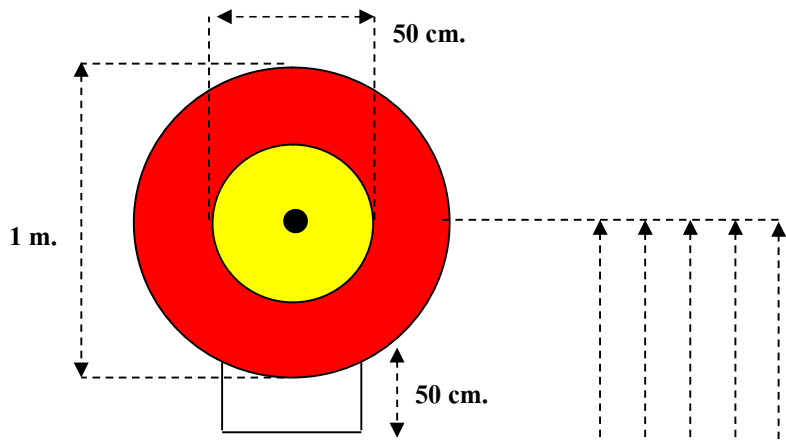

Distance	No.	Score Station				
		A	B	C	D	E
6 m.	1					
	2					
	3					
7 m.	1					
	2					
	3					
8 m.	1					
	2					
	3					
9 m.	1					
	2					
	3					
10 m.	1					
	2					
	3					
Total Score						

**Note. PORTEE**  
 Lancer la boule au-delà de la ligne (5 mètres depuis le cercle) pour finir à l'intérieur du cercle jaune, utilisant toutes les stations et distances.  
 .....  
 .....

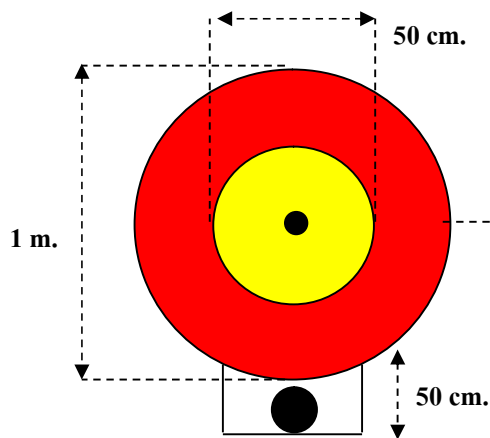

NOM .....

DATE ..... Total Score.....

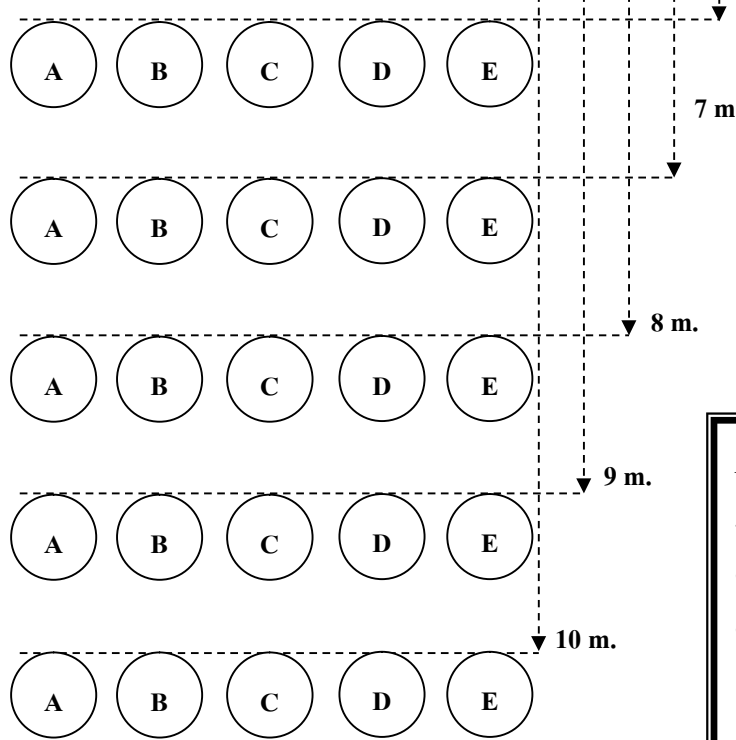

Distance	No.	Score Station				
		A	B	C	D	E
6 m.	1					
	2					
	3					
7 m.	1					
	2					
	3					
8 m.	1					
	2					
	3					
9 m.	1					
	2					
	3					
10 m.	1					
	2					
	3					
Total Score						

**Note.**  
 Jouer la boule pour éviter la boule obstacle (noire) par la droite ou la gauche, utilisant toutes les stations et distances et terminer à l'intérieur du cercle jaune.  
 .....  
 .....

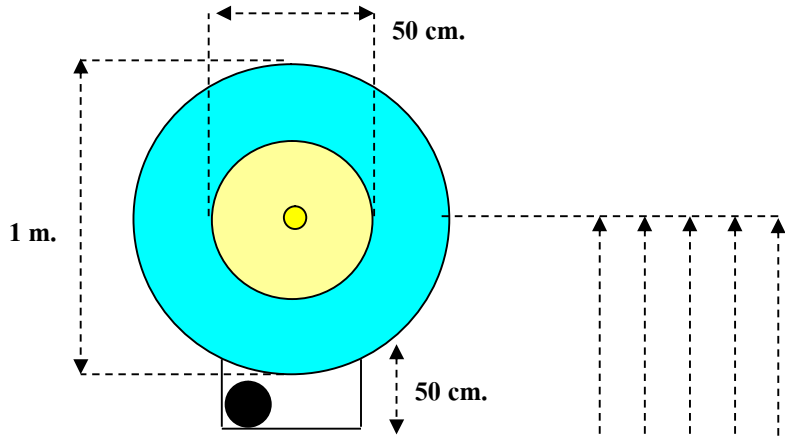

NOM .....

DATE .....Total Score.....

Distance	No.	Score Station				
		A	B	C	D	E
6 m.	1					
	2					
	3					
7 m.	1					
	2					
	3					
8 m.	1					
	2					
	3					
9 m.	1					
	2					
	3					
10 m.	1					
	2					
	3					
Total Score						

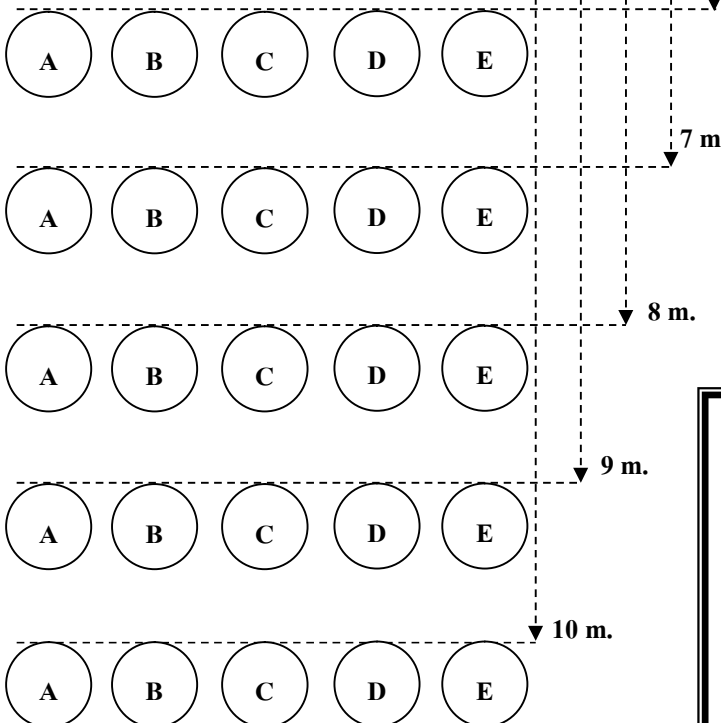

**Note.**  
 Jouer la boule par la droite pour éviter la boule obstacle, utilisant toutes les stations et distances et terminer à l'intérieur du cercle jaune.  
 .....

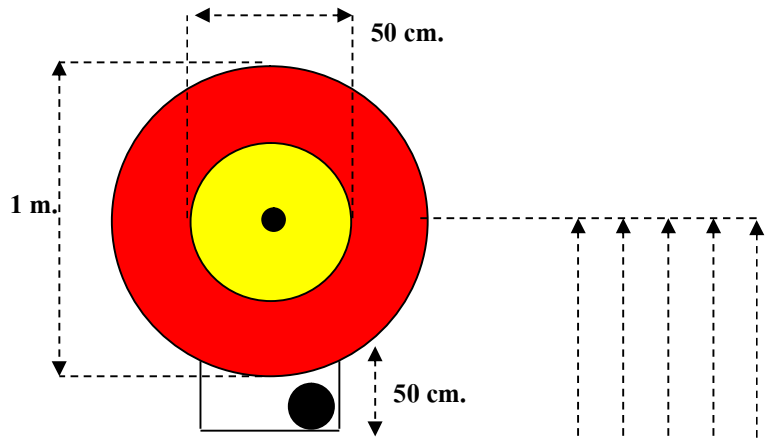

NOM .....

DATE ..... Total Score.....

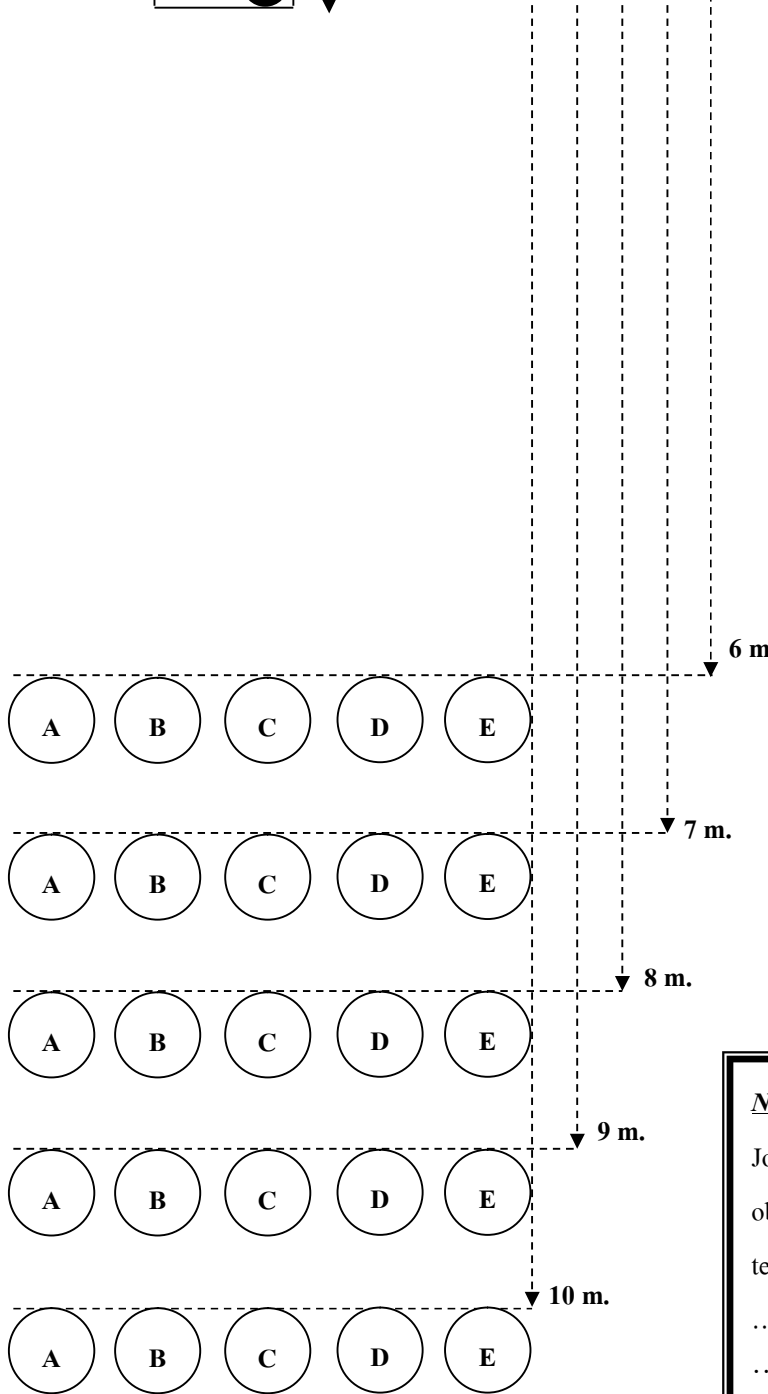

Distance	No.	Score Station				
		A	B	C	D	E
6 m.	1					
	2					
	3					
7 m.	1					
	2					
	3					
8 m.	1					
	2					
	3					
9 m.	1					
	2					
	3					
10 m.	1					
	2					
	3					
Total Score						

**Note.**  
 Jouer la boule par la gauche pour éviter la boule obstacle, utilisant toutes les stations et distances et terminer à l'intérieur du cercle jaune.  
 .....  
 .....

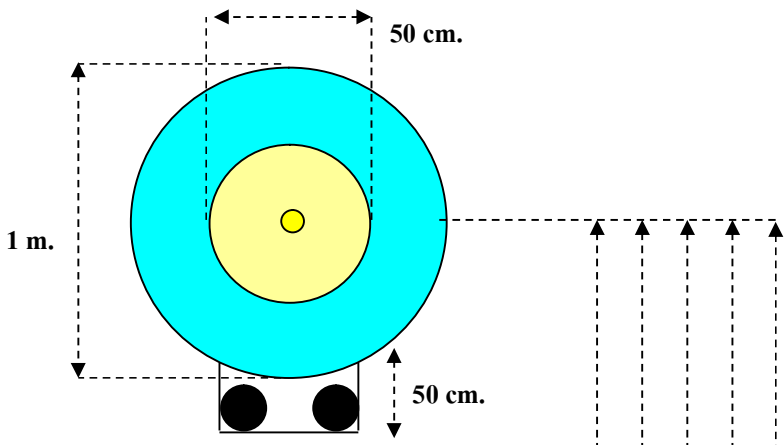

NOM .....

DATE ..... Total Score.....

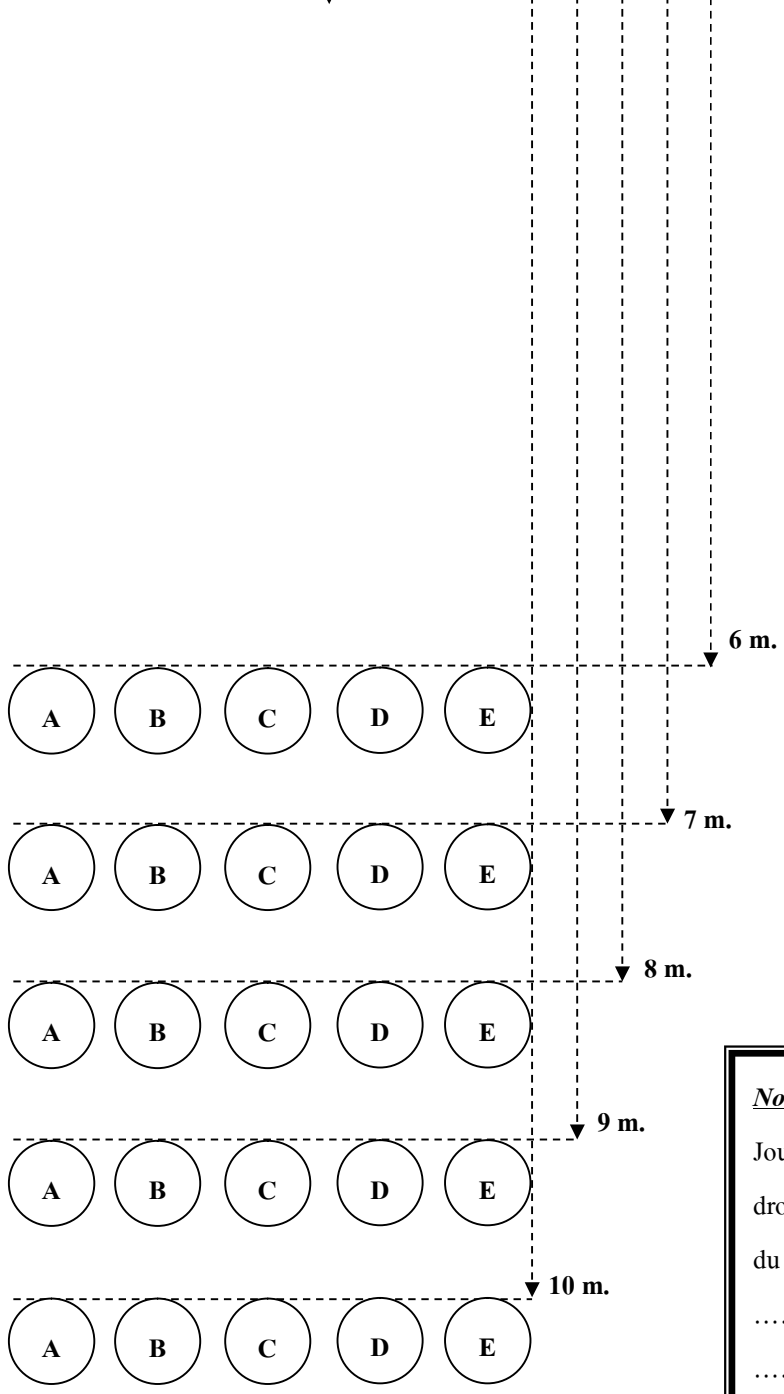

Distance	No.	Score Station				
		A	B	C	D	E
6 m.	1					
	2					
	3					
7 m.	1					
	2					
	3					
8 m.	1					
	2					
	3					
9 m.	1					
	2					
	3					
10 m.	1					
	2					
	3					
Total Score						

**Note.**  
 Jouer la boule pour éviter les 2 boules obstacles soit à droite, gauche ou au milieu pour terminer à l'intérieur du cercle jaune.  
 .....  
 .....

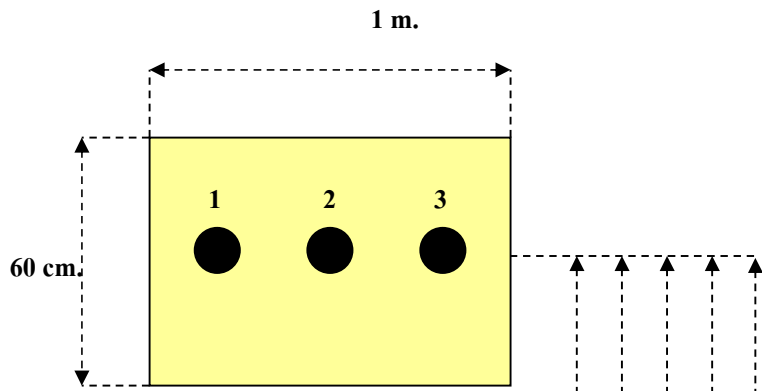

NOM .....

DATE .....Total Score.....

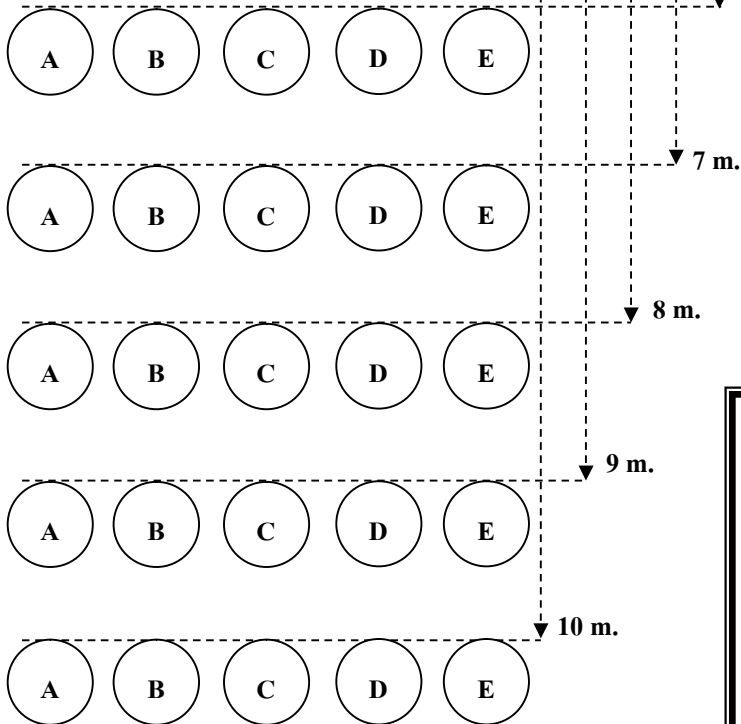

Distance	No.	Score Station				
		A	B	C	D	E
6 m.	1					
	2					
	3					
7 m.	1					
	2					
	3					
8 m.	1					
	2					
	3					
9 m.	1					
	2					
	3					
10 m.	1					
	2					
	3					
Total Score						

**Note.**  
 Tirer les boules au fer pour la sortir du rectangle,  
 utilisant toutes les stations et distances  
 .....  
 .....  
 .....



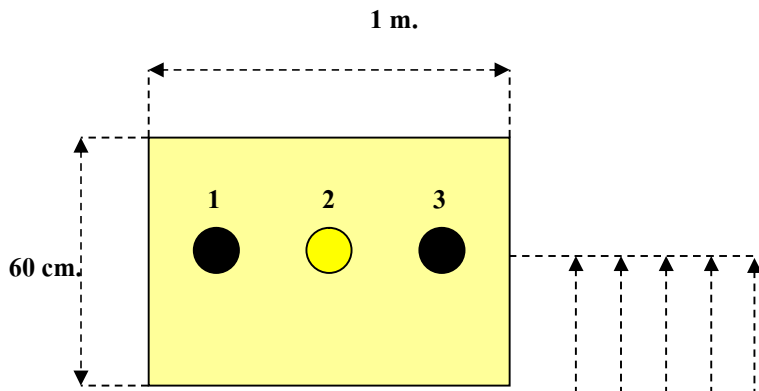

NOM .....

DATE .....Total Score.....

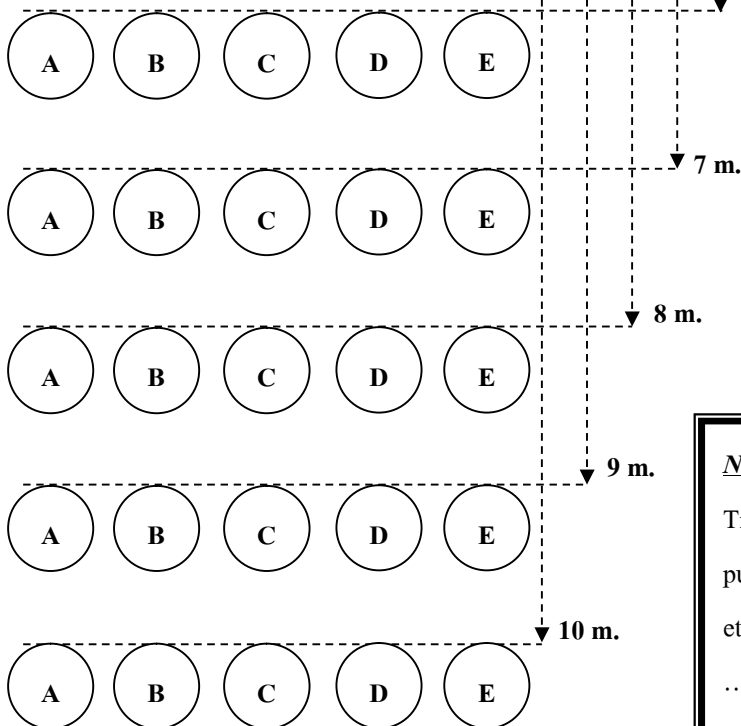

Distance	No.	Score Station				
		A	B	C	D	E
6 m.	1					
	2					
	3					
7 m.	1					
	2					
	3					
8 m.	1					
	2					
	3					
9 m.	1					
	2					
	3					
10 m.	1					
	2					
	3					
Total Score						

**Note.**  
 Tirer au fer la boule jaune pour la sortir du rectangle  
 puis la boule 1 et la boule 3, utilisant toutes les stations  
 et distances  
 .....  
 .....

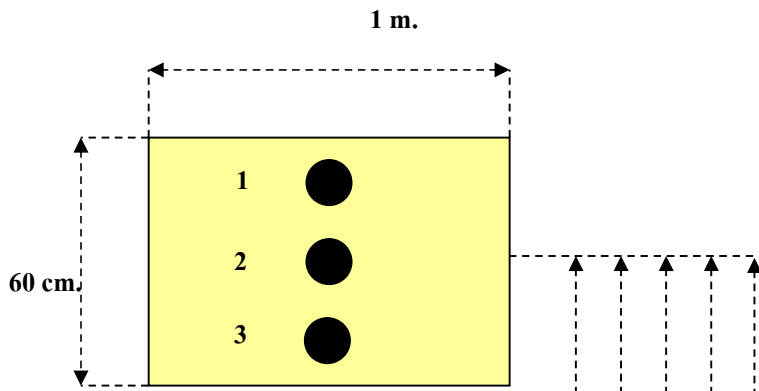

NOM .....

DATE ..... Total Score.....

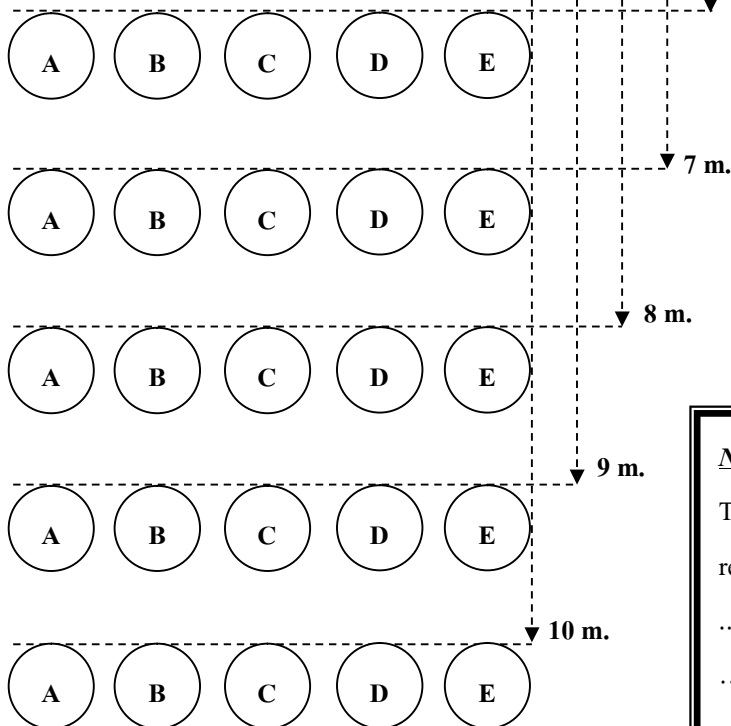

Distance	No.	Score Station				
		A	B	C	D	E
6 m.	1					
	2					
	3					
7 m.	1					
	2					
	3					
8 m.	1					
	2					
	3					
9 m.	1					
	2					
	3					
10 m.	1					
	2					
	3					
Total Score						

**Note.**  
 Tirer les boules dans l'ordre (1, 2, 3) pour les sortir du rectangle, utilisant toutes les stations et distances.  
 .....  
 .....  
 .....

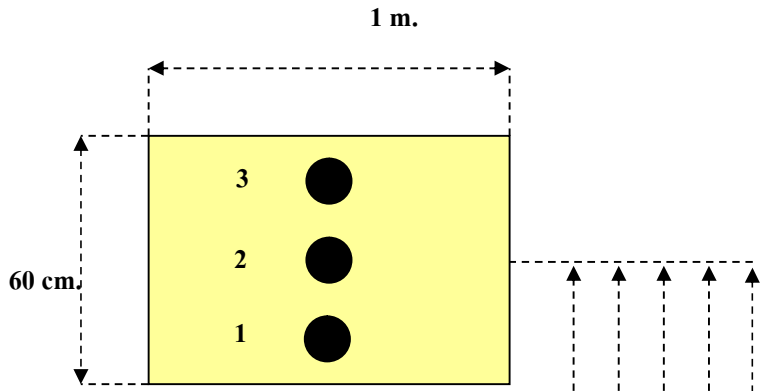

NOM .....

DATE ..... Total Score.....

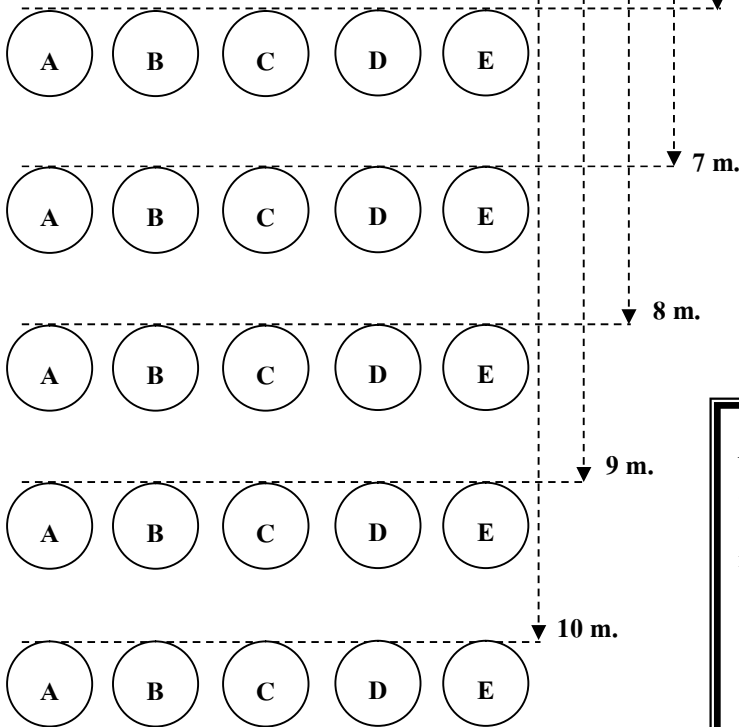

Distance	No.	Score Station				
		A	B	C	D	E
6 m.	1					
	2					
	3					
7 m.	1					
	2					
	3					
8 m.	1					
	2					
	3					
9 m.	1					
	2					
	3					
10 m.	1					
	2					
	3					
Total Score						

**Note.**  
 Tirer les boules dans l'ordre (1, 2, 3) pour les sortir du rectangle, utilisant toutes les stations et distances.  
 .....  
 .....  
 .....

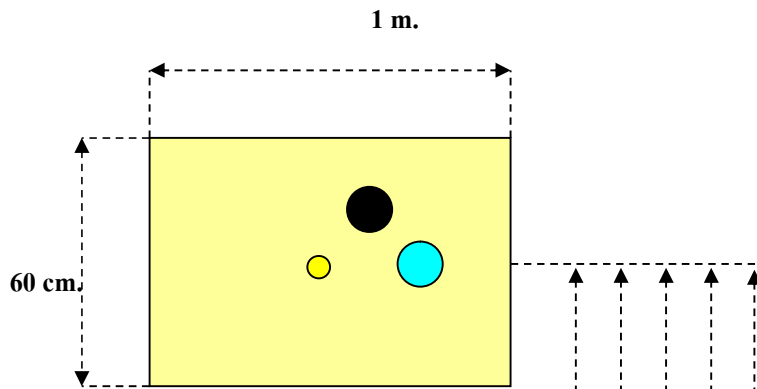

NOM .....

DATE .....Total Score.....

Distance	No.	Score Station				
		A	B	C	D	E
6 m.	1					
	2					
	3					
7 m.	1					
	2					
	3					
8 m.	1					
	2					
	3					
9 m.	1					
	2					
	3					
10 m.	1					
	2					
	3					
Total Score						

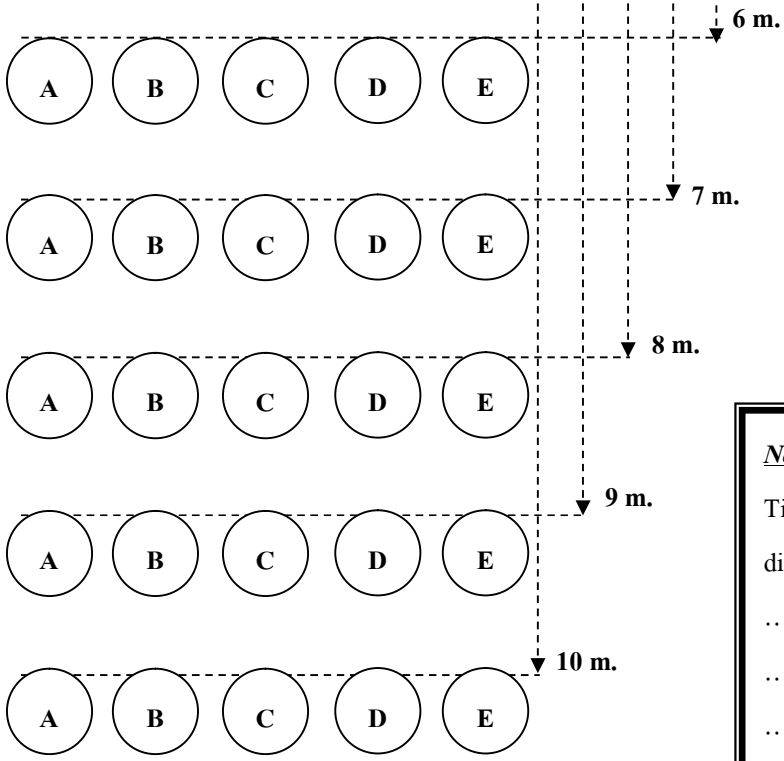

**Note.**  
 Tirer la boule noire seule, utilisant toutes les stations et distances.  
 .....  
 .....  
 .....

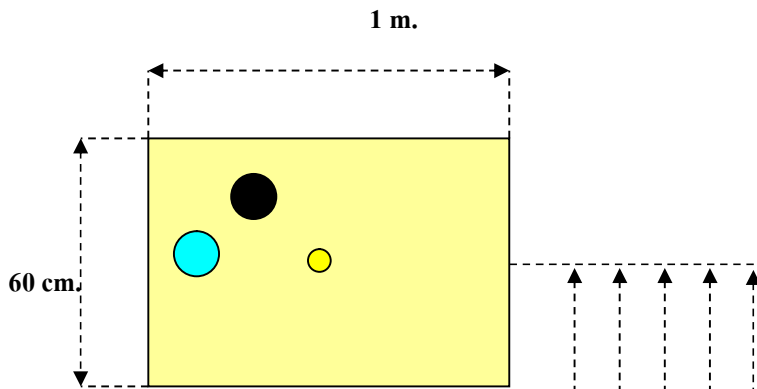

NOM .....

DATE .....Total Score.....

Distance	No.	Score Station				
		A	B	C	D	E
6 m.	1					
	2					
	3					
7 m.	1					
	2					
	3					
8 m.	1					
	2					
	3					
9 m.	1					
	2					
	3					
10 m.	1					
	2					
	3					
Total Score						

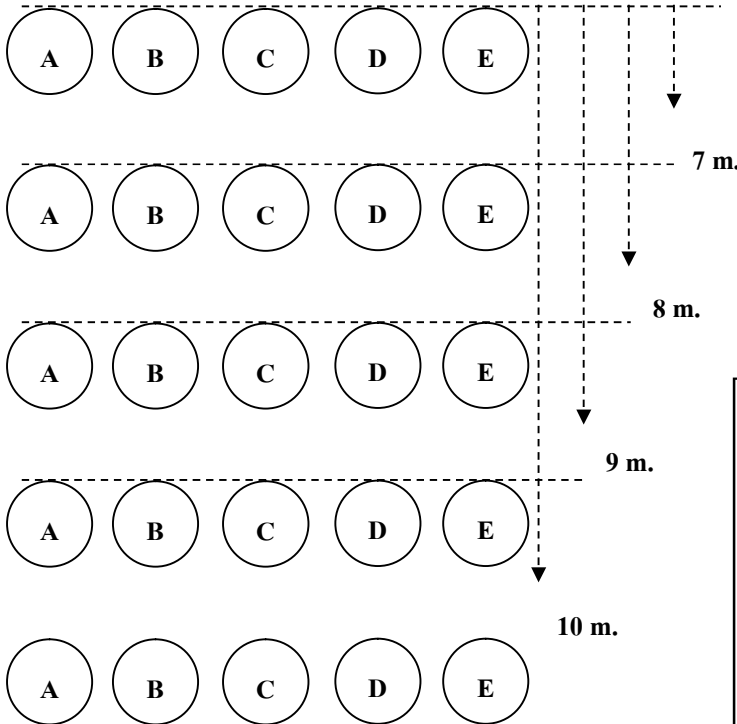

**Note.**  
 Tirer la boule noire seule, utilisant toutes les stations et distances.  
 .....  
 .....  
 .....

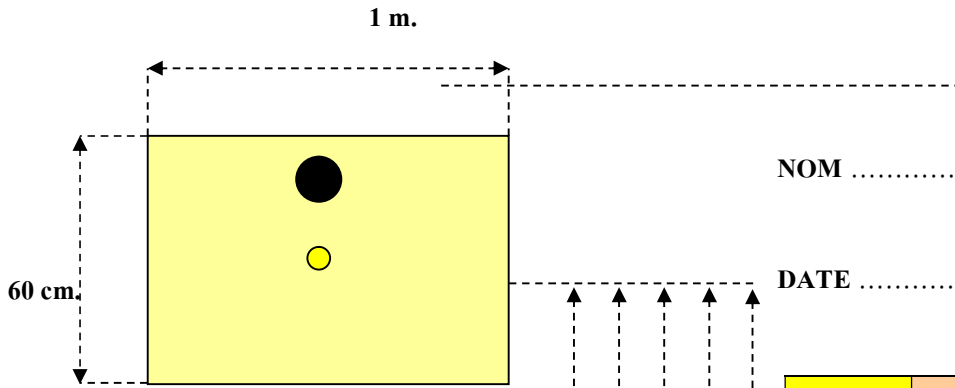

NOM .....

DATE ..... Total Score.....

Distance	No.	Score Station				
		A	B	C	D	E
6 m.	1					
	2					
	3					
7 m.	1					
	2					
	3					
8 m.	1					
	2					
	3					
9 m.	1					
	2					
	3					
10 m.	1					
	2					
	3					
Total Score						

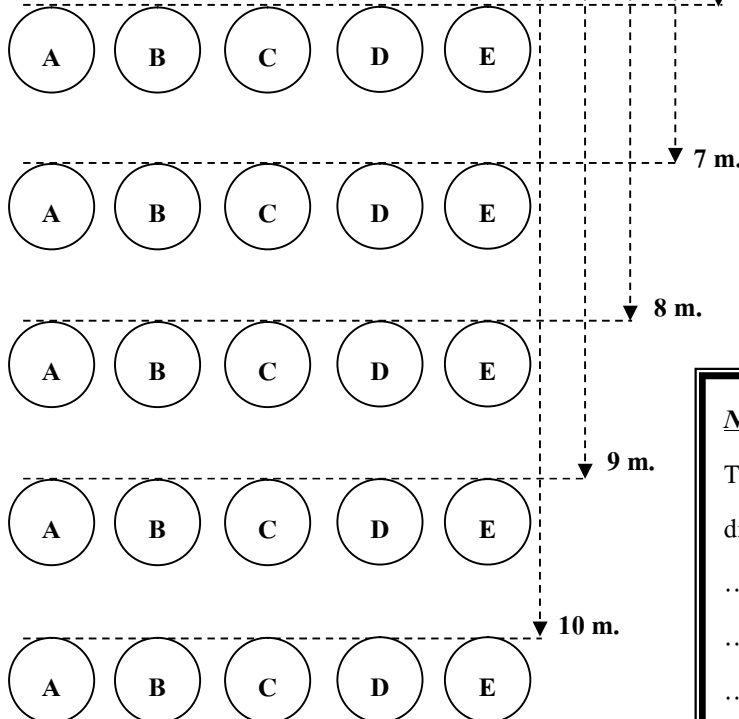

**Note.**  
 Tirer la boule noire seule, utilisant toutes les stations et distances.  
 .....  
 .....  
 .....

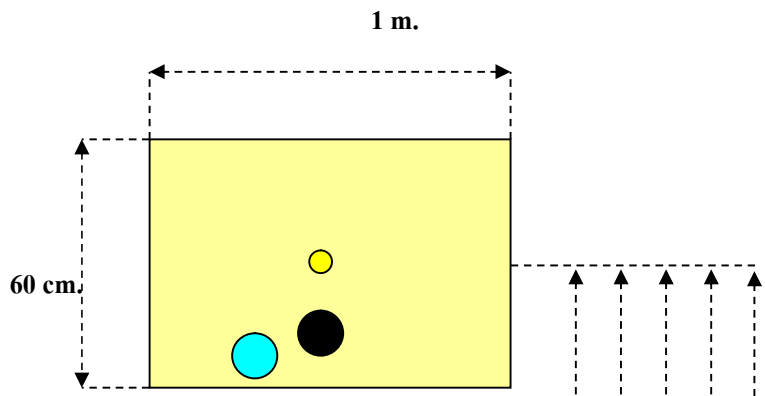

NOM .....

DATE .....Total Score.....

Distance	No.	Score Station				
		A	B	C	D	E
6 m.	1					
	2					
	3					
7 m.	1					
	2					
	3					
8 m.	1					
	2					
	3					
9 m.	1					
	2					
	3					
10 m.	1					
	2					
	3					
Total Score						

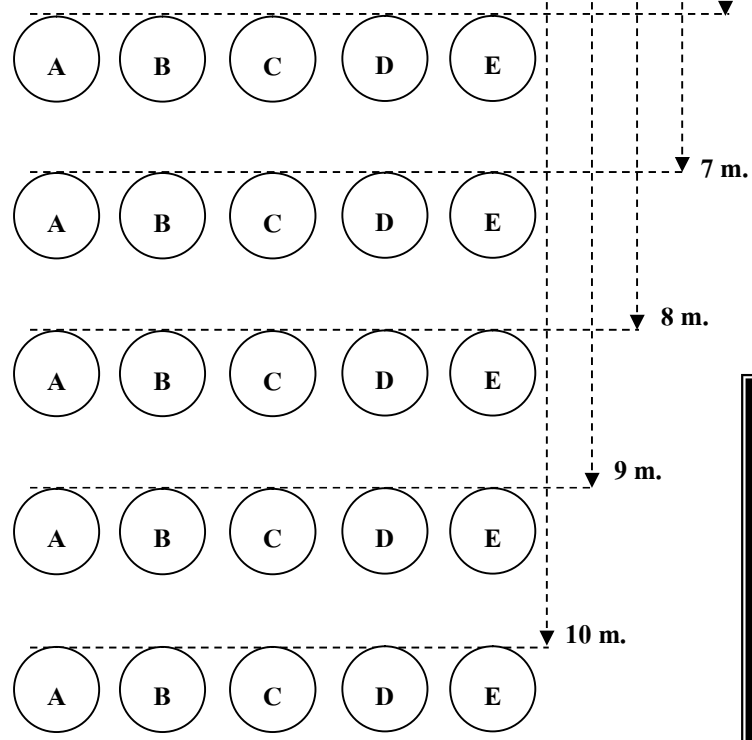

**Note.**  
 Tirer la boule noire seule, utilisant toutes les stations et distances.  
 .....  
 .....  
 .....

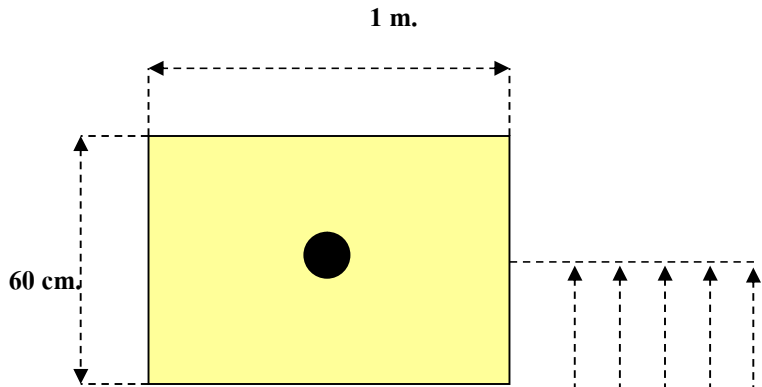

NOM .....

DATE .....Total Score.....

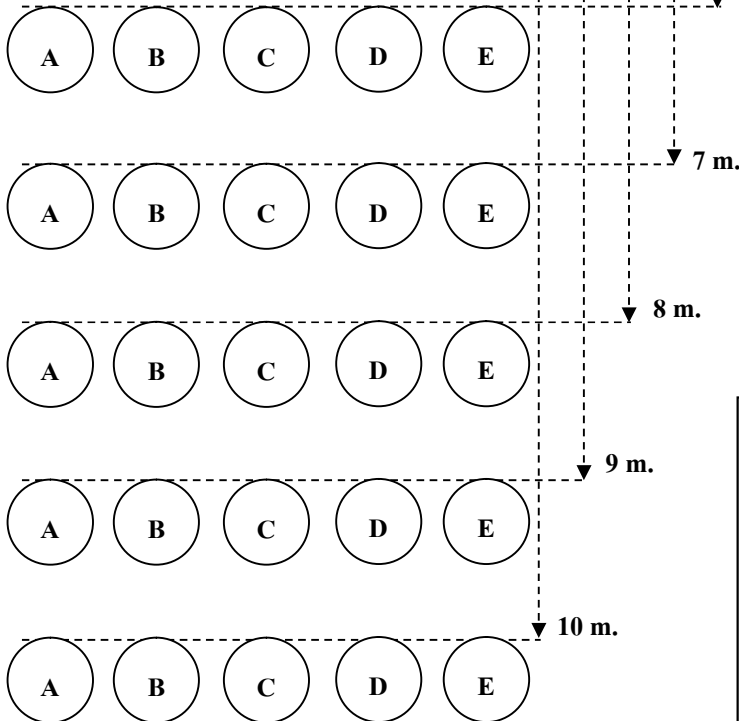

Distance	No.	Score Station				
		A	B	C	D	E
6 m.	1					
	2					
	3					
7 m.	1					
	2					
	3					
8 m.	1					
	2					
	3					
9 m.	1					
	2					
	3					
10 m.	1					
	2					
	3					
Total Score						

**Note.**  
 Tirer la boule noire seule, utilisant toutes les stations et distances.  
 .....  
 .....  
 .....



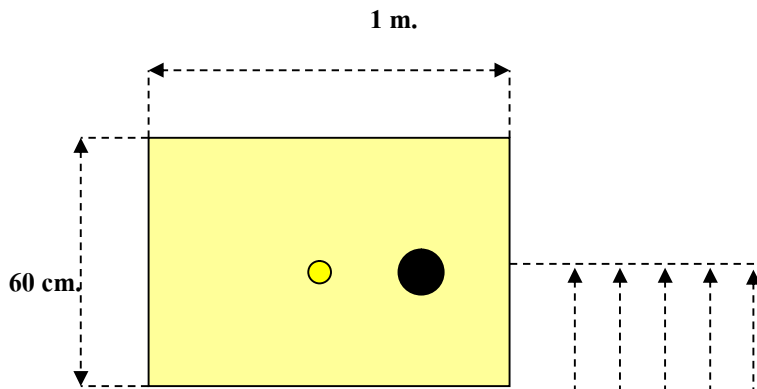

NOM .....

DATE .....Total Score.....

Distance	No.	Score Station				
		A	B	C	D	E
6 m.	1					
	2					
	3					
7 m.	1					
	2					
	3					
8 m.	1					
	2					
	3					
9 m.	1					
	2					
	3					
10 m.	1					
	2					
	3					
Total Score						

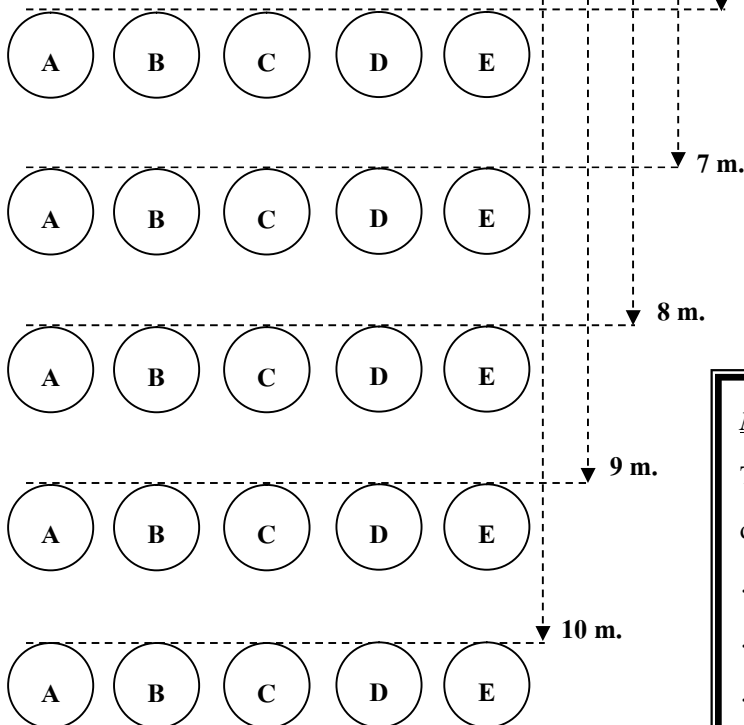

**Note.**  
 Tirer la boule noire seule, utilisant toutes les stations et distances.  
 .....  
 .....  
 .....

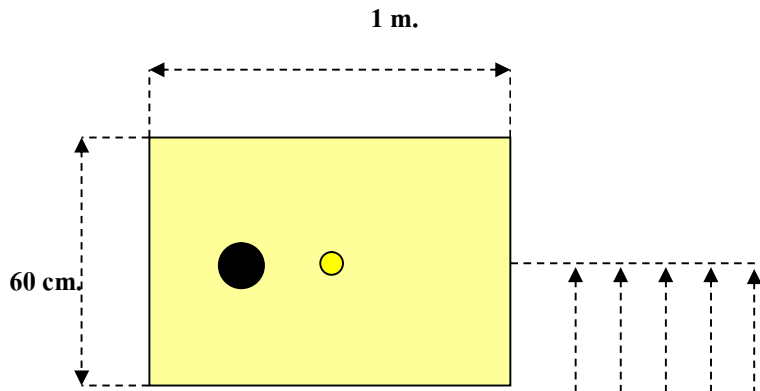

NOM .....

DATE ..... Total Score.....

Distance	No.	Score Station				
		A	B	C	D	E
6 m.	1					
	2					
	3					
7 m.	1					
	2					
	3					
8 m.	1					
	2					
	3					
9 m.	1					
	2					
	3					
10 m.	1					
	2					
	3					
Total Score						

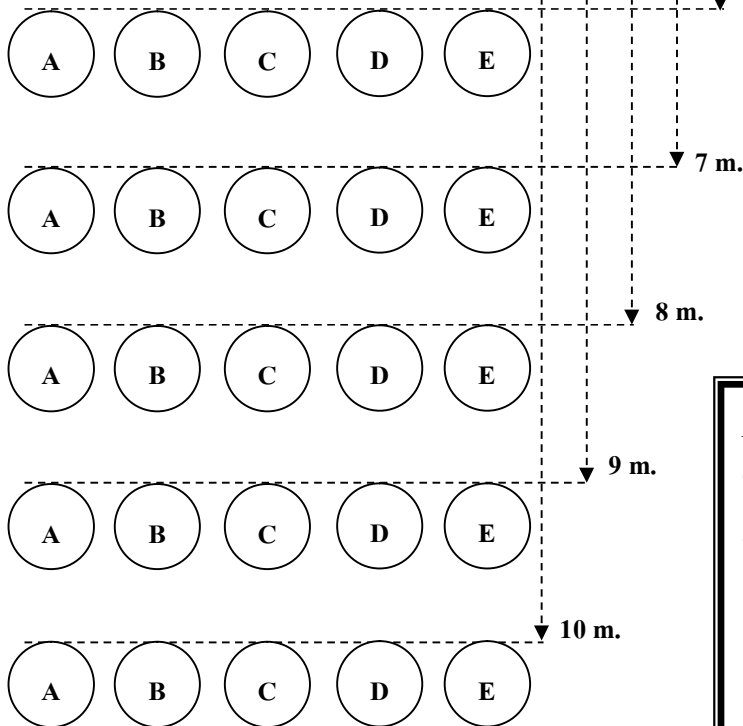

**Note.**  
 Tirer la boule noire seule, utilisant toutes les stations et distances.  
 .....  
 .....  
 .....

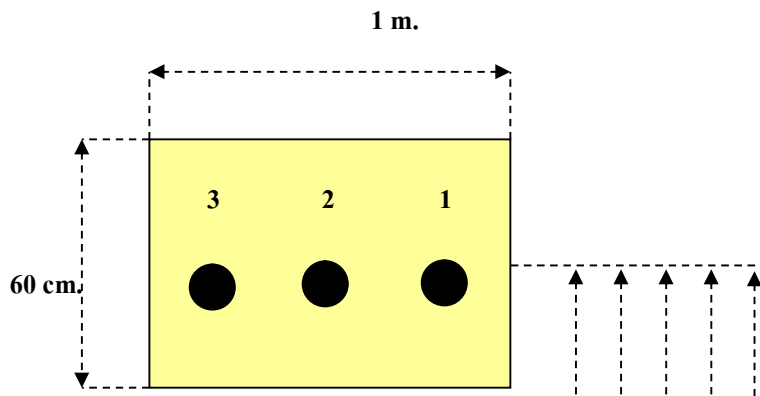

NOM .....

DATE .....Total Score.....

Distance	No.	Score Station				
		A	B	C	D	E
6 m.	1					
	2					
	3					
7 m.	1					
	2					
	3					
8 m.	1					
	2					
	3					
9 m.	1					
	2					
	3					
10 m.	1					
	2					
	3					
Total Score						

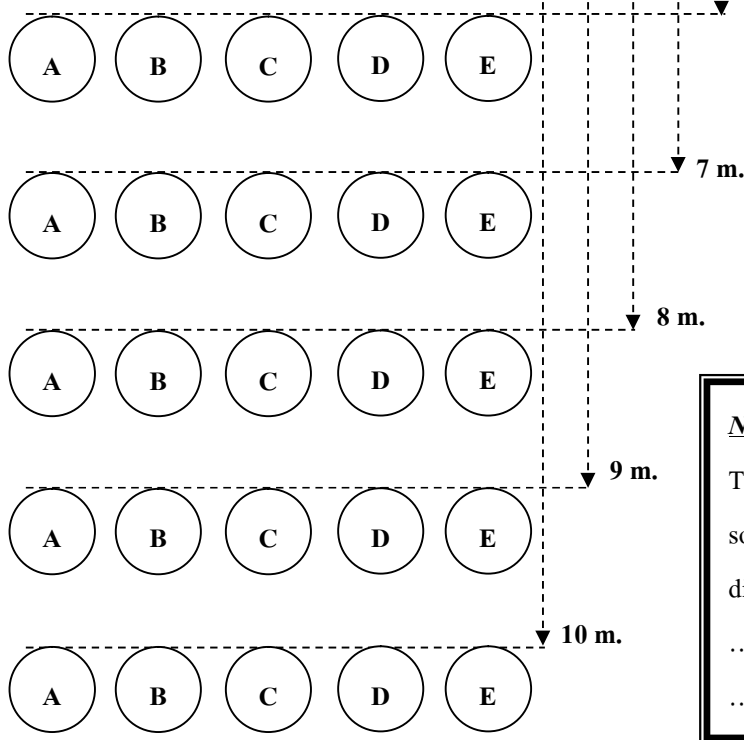

**Note.**  
 Tirer au fer les boules dans l'ordre 1, 2, 3 pour les sortir du rectangle, utilisant toutes les stations et distances.  
 .....  
 .....

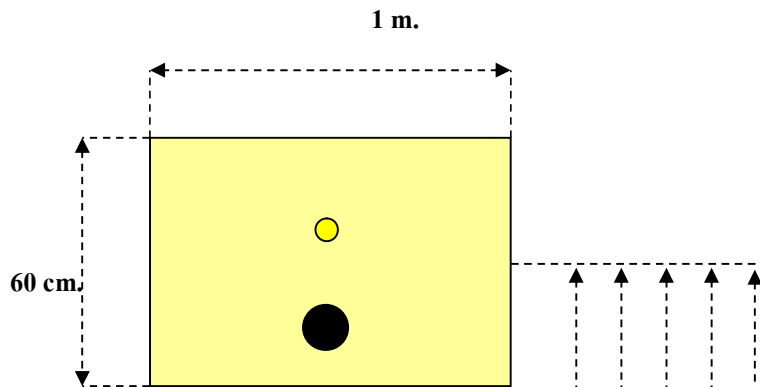

NOM .....

DATE .....Total Score.....

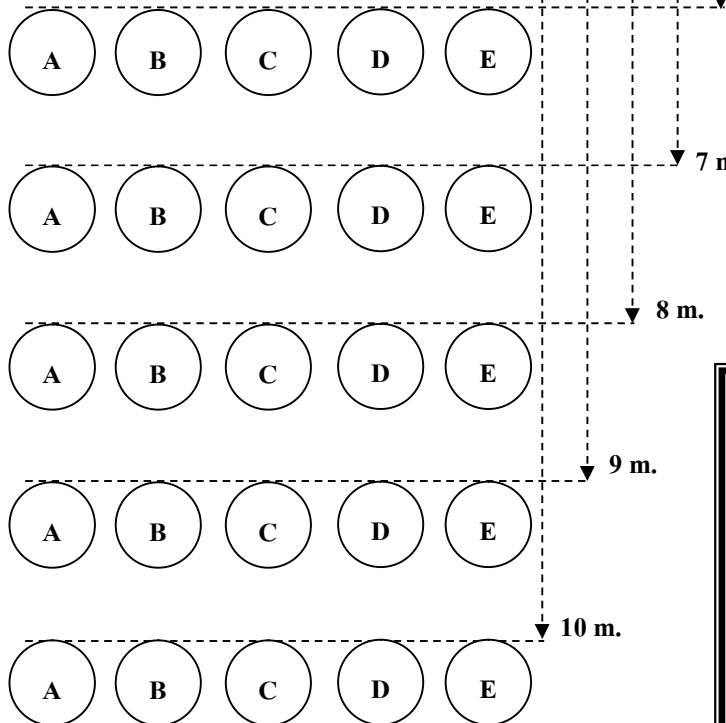

Distance	No.	Score Station				
		A	B	C	D	E
6 m.	1					
	2					
	3					
7 m.	1					
	2					
	3					
8 m.	1					
	2					
	3					
9 m.	1					
	2					
	3					
10 m.	1					
	2					
	3					
Total Score						

**Note.**  
 Tirer la boule noire seule, utilisant toutes les stations et distances.  
 .....  
 .....  
 .....

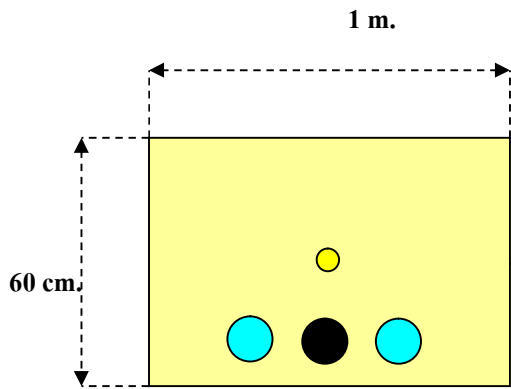

NOM .....

DATE .....Total Score.....

Distance	No.	Score Station				
		A	B	C	D	E
6 m.	1					
	2					
	3					
7 m.	1					
	2					
	3					
8 m.	1					
	2					
	3					
9 m.	1					
	2					
	3					
10 m.	1					
	2					
	3					
Total Score						

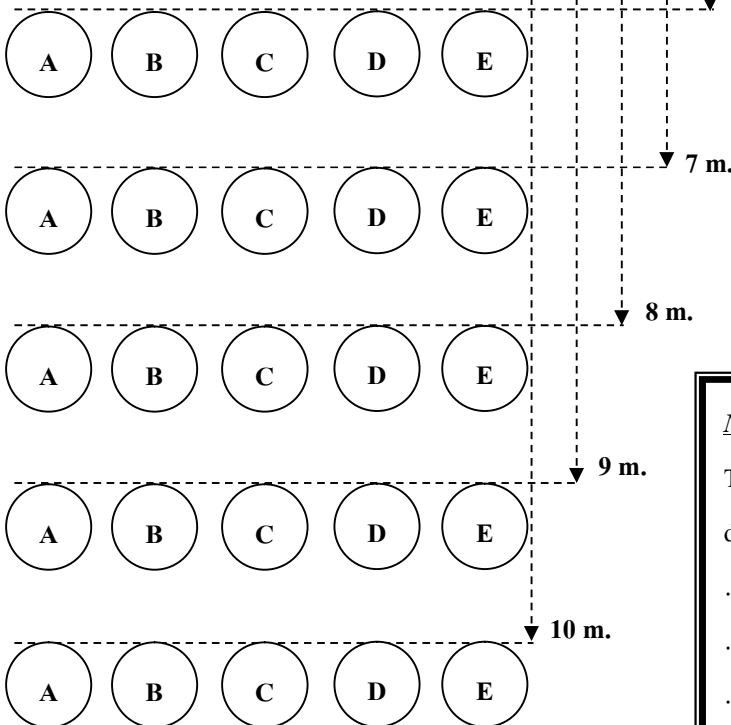

**Note.**  
 Tirer la boule noire seule, utilisant toutes les stations et distances.  
 .....  
 .....  
 .....

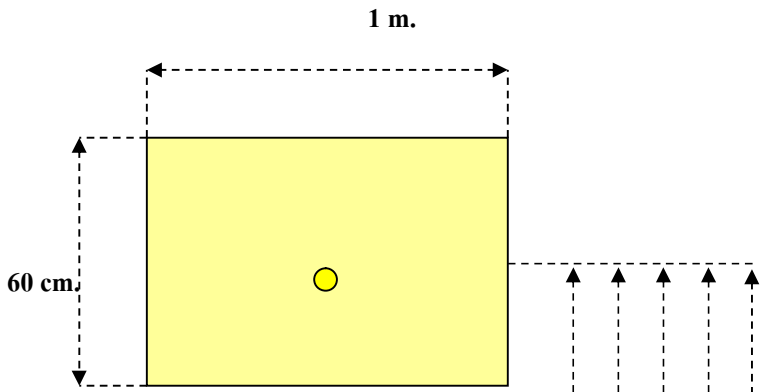

NOM .....

DATE .....Total Score.....

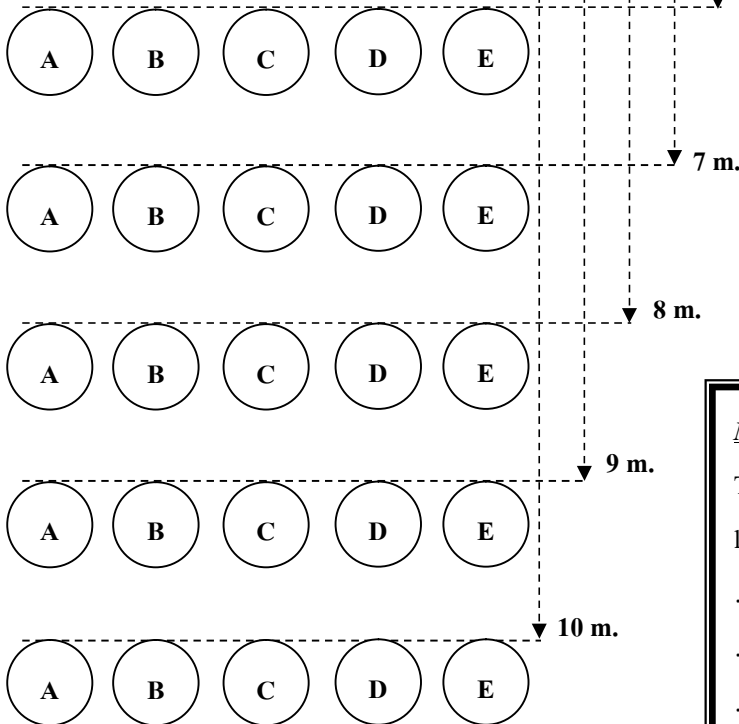

Distance	No.	Score Station				
		A	B	C	D	E
6 m.	1					
	2					
	3					
7 m.	1					
	2					
	3					
8 m.	1					
	2					
	3					
9 m.	1					
	2					
	3					
10 m.	1					
	2					
	3					
Total Score						

**Note.**  
 Tirer le but pour le sortir du rectangle, utilisant toutes les stations et distances.  
 .....  
 .....  
 .....

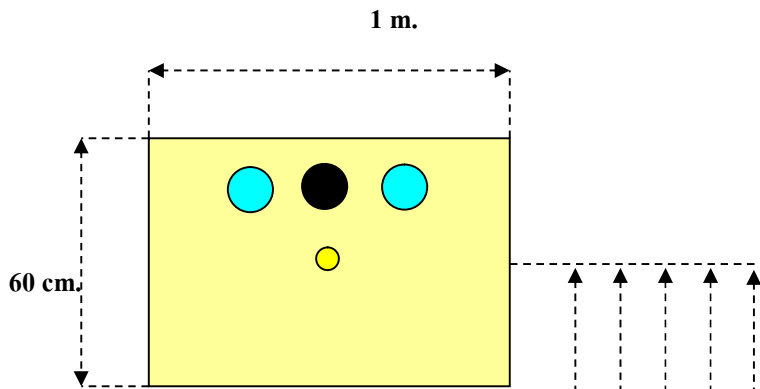

NOM .....

DATE ..... Total Score.....

Distance	No.	Score Station				
		A	B	C	D	E
6 m.	1					
	2					
	3					
7 m.	1					
	2					
	3					
8 m.	1					
	2					
	3					
9 m.	1					
	2					
	3					
10 m.	1					
	2					
	3					
Total Score						

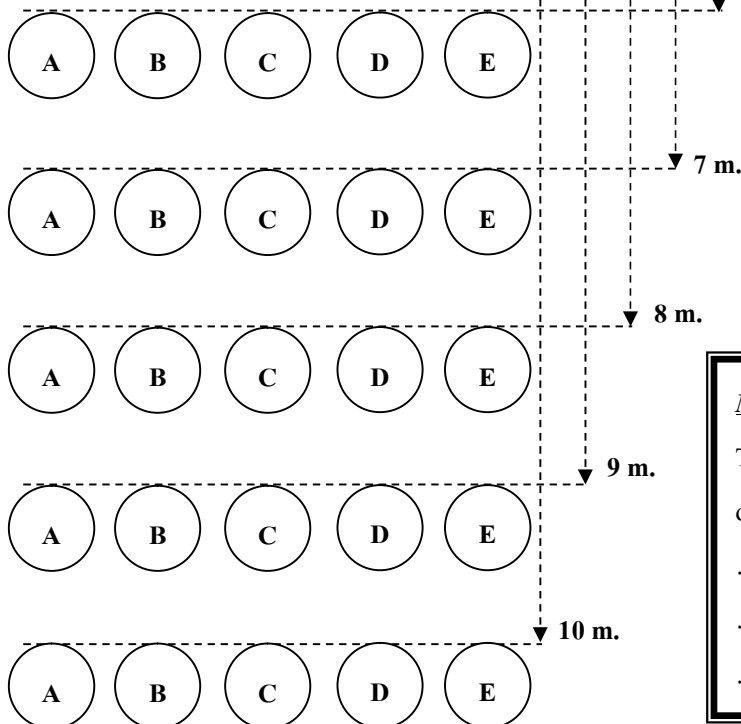

**Note.**  
 Tirer la boule noire seule, utilisant toutes les stations et distances.  
 .....  
 .....  
 .....

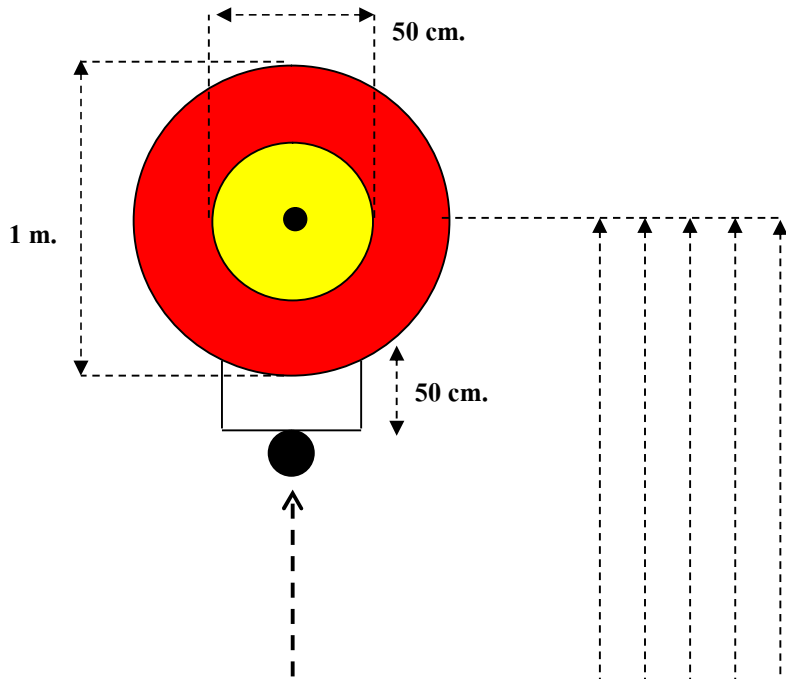

NOM .....

DATE .....Total Score.....

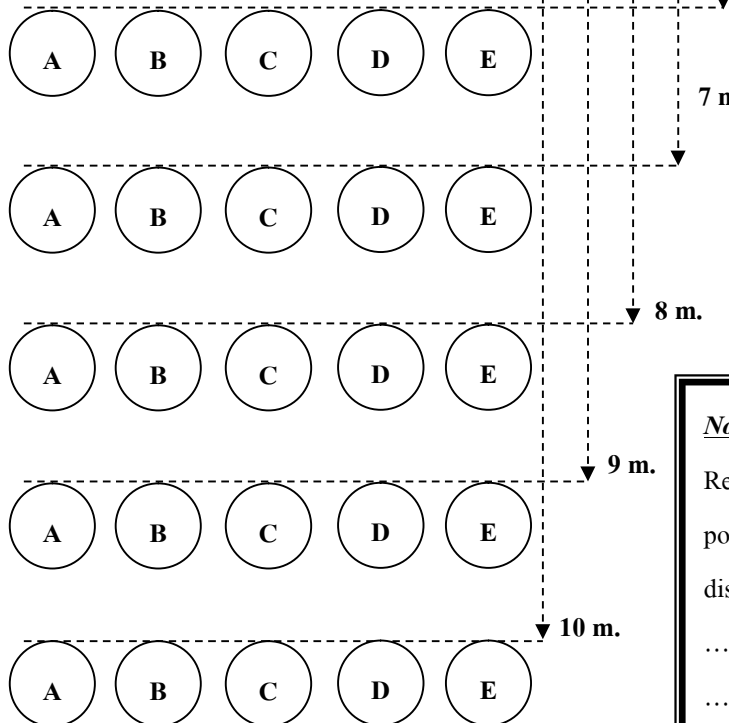

Distance	No.	Score Station				
		A	B	C	D	E
6 m.	1					
	2					
	3					
7 m.	1					
	2					
	3					
8 m.	1					
	2					
	3					
9 m.	1					
	2					
	3					
10 m.	1					
	2					
	3					
Total Score						

**Note.**  
 Rentrer la boule noire à l'intérieur du cercle jaune pour faire 2 points, utilisant toutes les stations et distances.  
 .....  
 .....



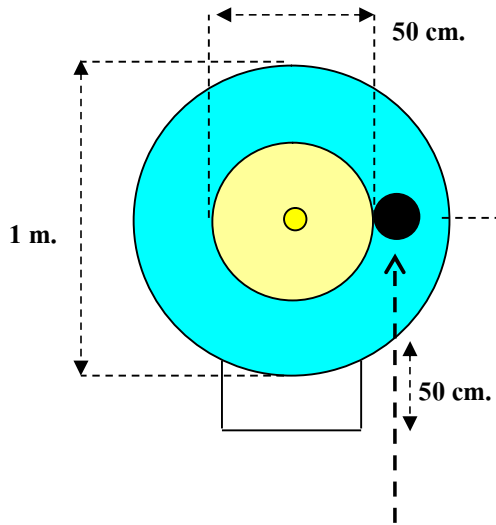

NOM .....

DATE ..... Total Score.....

Distance	No.	Score Station				
		A	B	C	D	E
6 m.	1					
	2					
	3					
7 m.	1					
	2					
	3					
8 m.	1					
	2					
	3					
6 m. 9 m.	1					
	2					
	3					
10 m.	1					
	2					
	3					
Total Score						

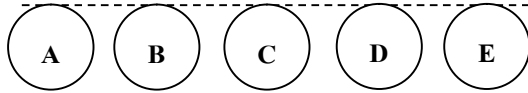
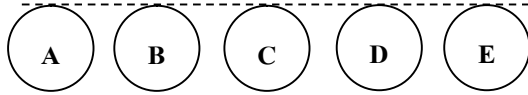
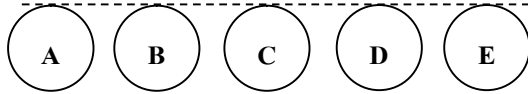
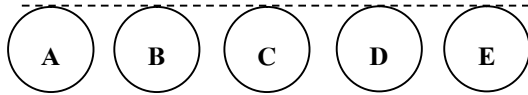
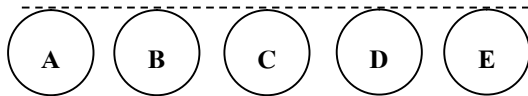

**Note.**  
 Jouer la boule noire pour la sortir du cercle, utilisant toutes les stations et distances.  
 .....  
 .....  
 .....

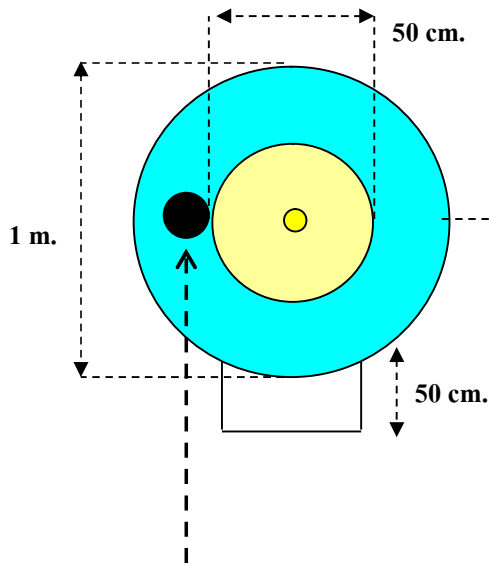

NOM .....

DATE ..... Total Score.....

Distance	No.	Score Station				
		A	B	C	D	E
6 m.	1					
	2					
	3					
7 m.	1					
	2					
	3					
8 m.	1					
	2					
	3					
9 m.	1					
	2					
	3					
10 m.	1					
	2					
	3					
Total Score						

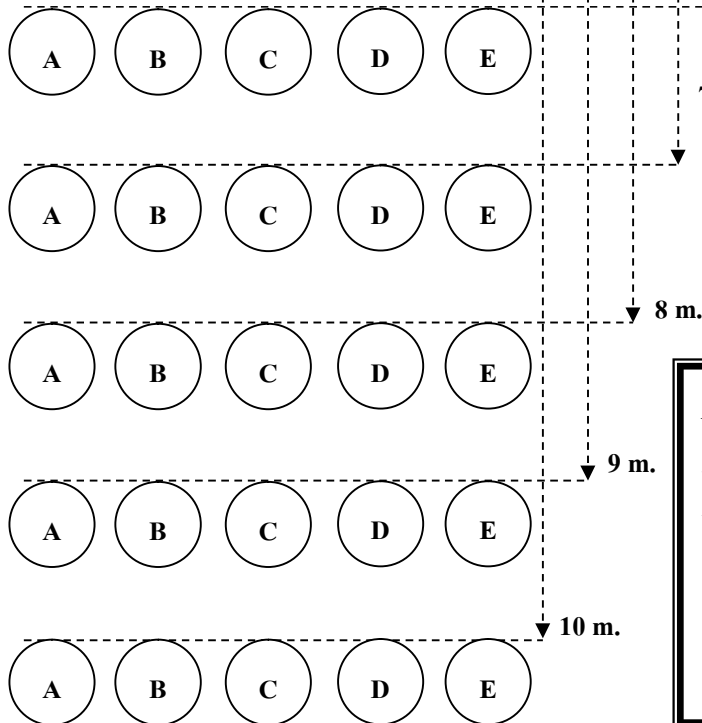

**Note.**  
 Jouer la boule noire pour la sortir du cercle, utilisant toutes les stations et distances.  
 .....  
 .....  
 .....

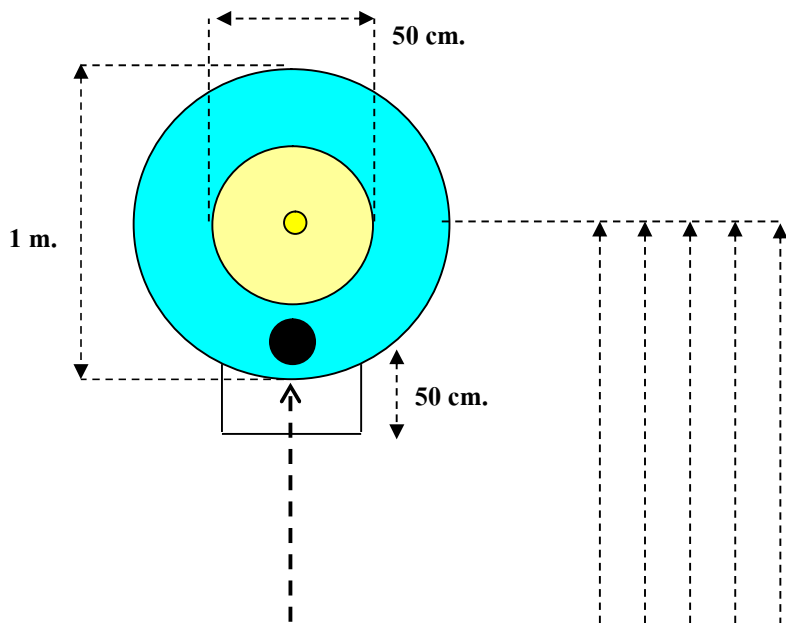

NOM .....

DATE ..... Total Score.....

Distance	No.	Score Station				
		A	B	C	D	E
6 m.	1					
	2					
	3					
7 m.	1					
	2					
	3					
8 m.	1					
	2					
	3					
6 m. 9 m.	1					
	2					
	3					
10 m.	1					
	2					
	3					
Total Score						

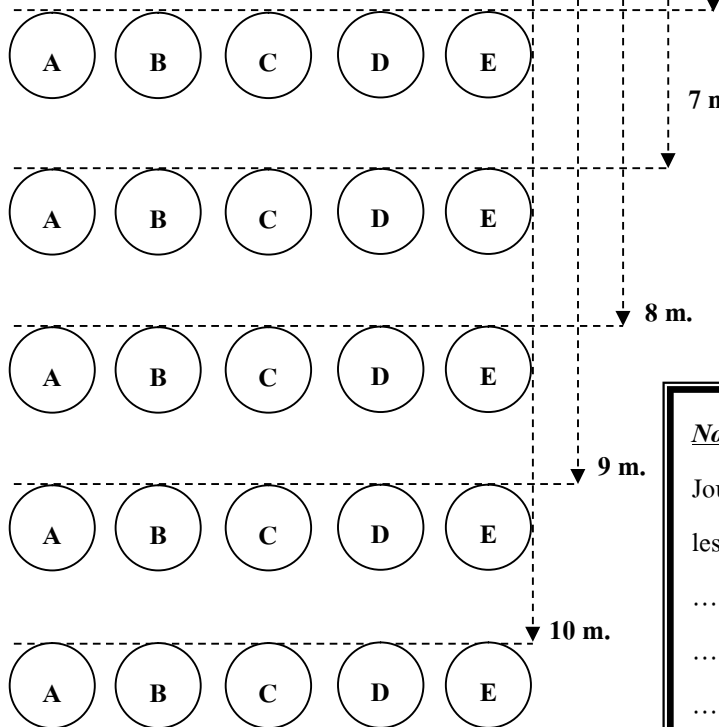

**Note.**  
 Jouer la boule pour la sortir du cercle, utilisant toutes les stations et distances.  
 .....  
 .....  
 .....

**TIR**

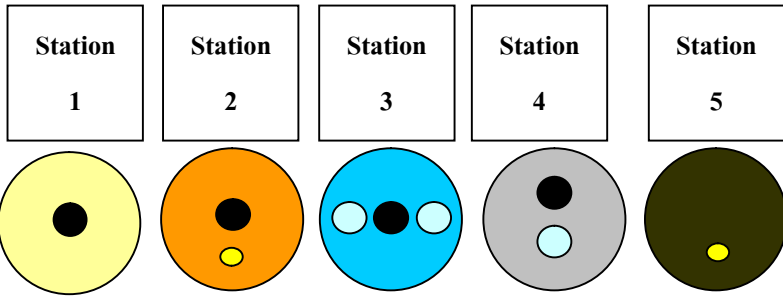

NOM .....

DATE ..... Total Score.....

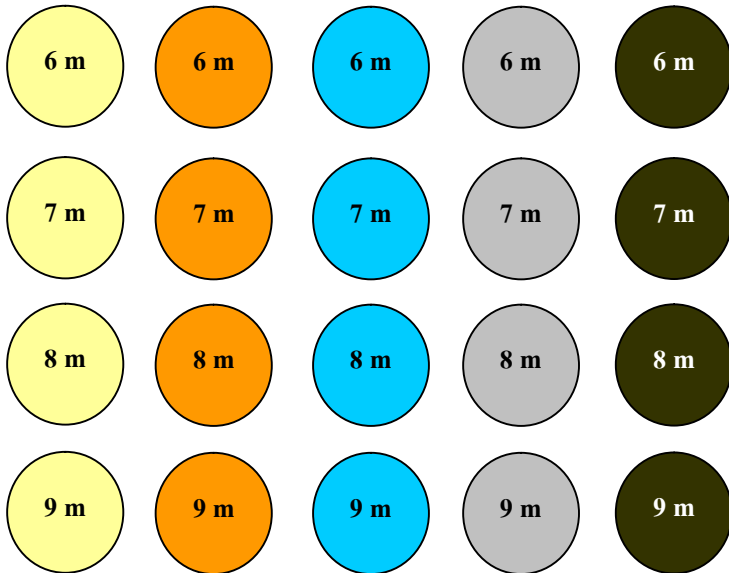

Station	Distance	Score			
		5	3	1	0
1	6 m.				
	7 m.				
	8 m.				
	9 m.				
2	6 m.				
	7 m.				
	8 m.				
	9 m.				
3	6 m.				
	7 m.				
	8 m.				
	9 m.				
4	6 m.				
	7 m.				
	8 m.				
	9 m.				
5	6 m.				
	7 m.				
	8 m.				
	9 m.				
	<b>Total Score</b>				

# Rapport par joueur

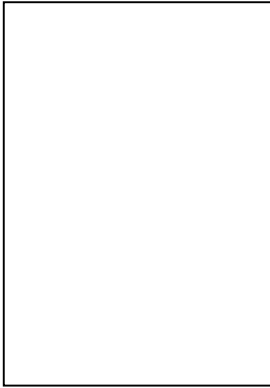

**NOM**.....

**Position**.....

Photo