

NAME

DATETotal Score.....

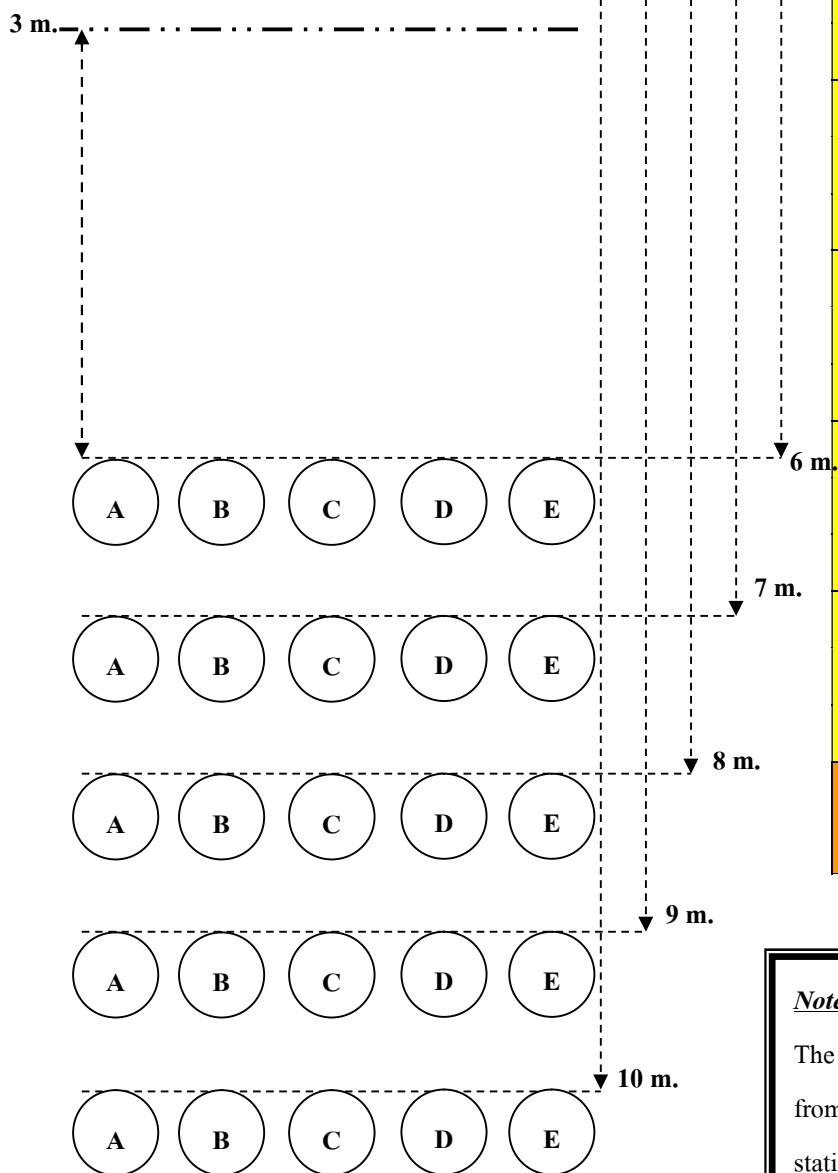

Distance	No.	Score Station				
		A	B	C	D	E
6 m.	1					
	2					
	3					
7 m.	1					
	2					
	3					
8 m.	1					
	2					
	3					
9 m.	1					
	2					
	3					
10 m.	1					
	2					
	3					
Total Score						

Note This exercise for rehearse half-lob pattern. The player must throw the ball over the line (3 m. from the start point) into the yellow circle using all stations and distances.

.....

.....

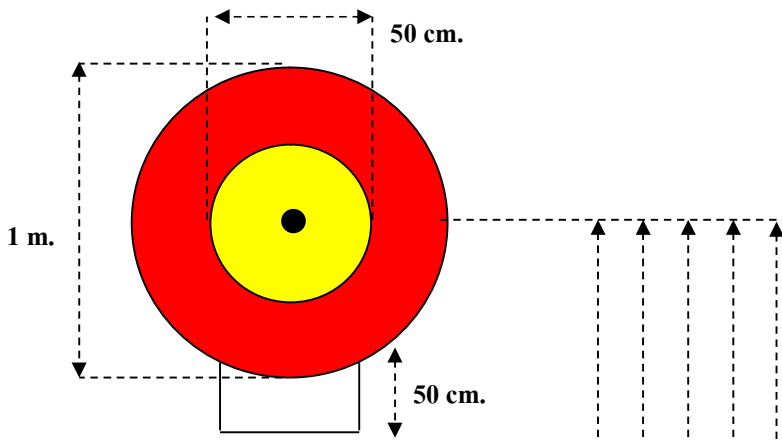

NAME

DATE Total Score.....

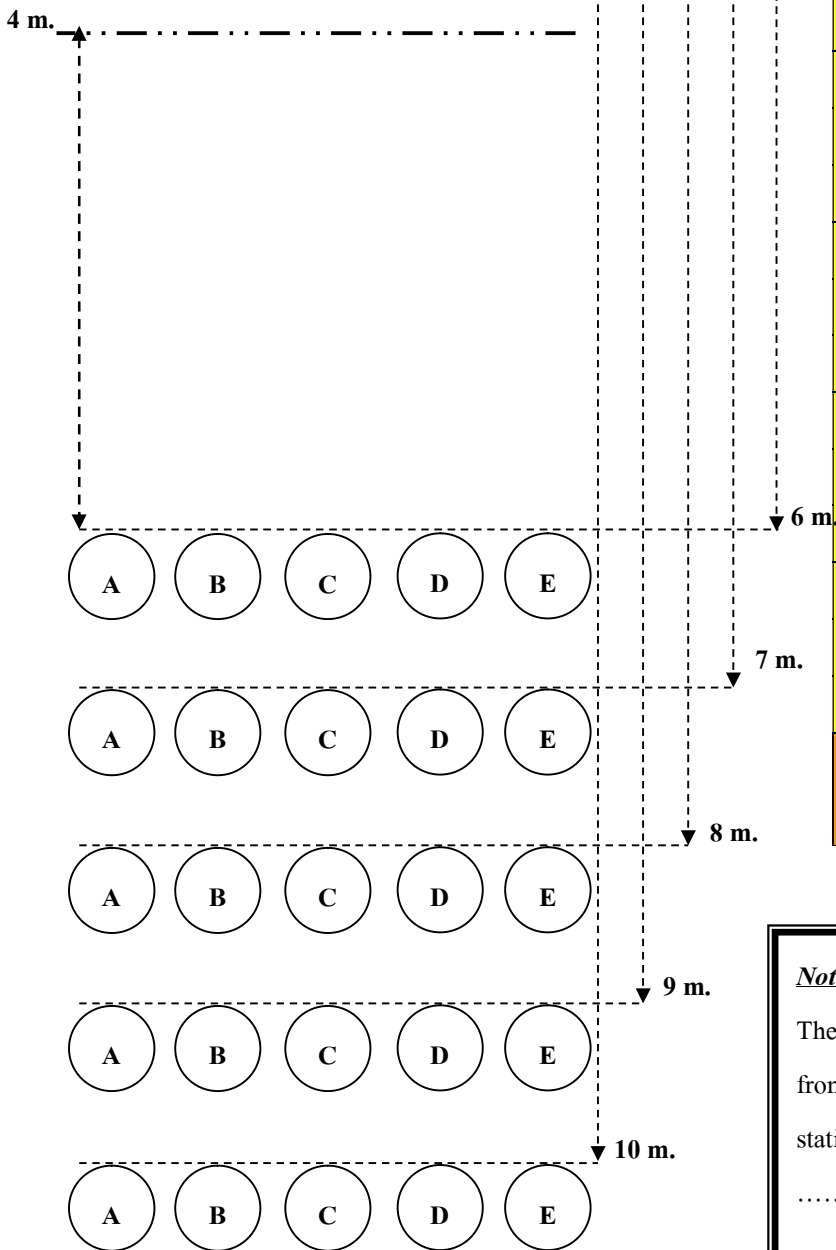

Distance	No.	Score Station				
		A	B	C	D	E
6 m.	1					
	2					
	3					
7 m.	1					
	2					
	3					
8 m.	1					
	2					
	3					
9 m.	1					
	2					
	3					
10 m.	1					
	2					
	3					
Total Score						

Note This exercise for rehearse high lob pattern. The player must throw the ball over the line (4 m. from the start point) into the yellow circle, using all stations and distances.

.....

.....

NAME

DATETotal Score.....

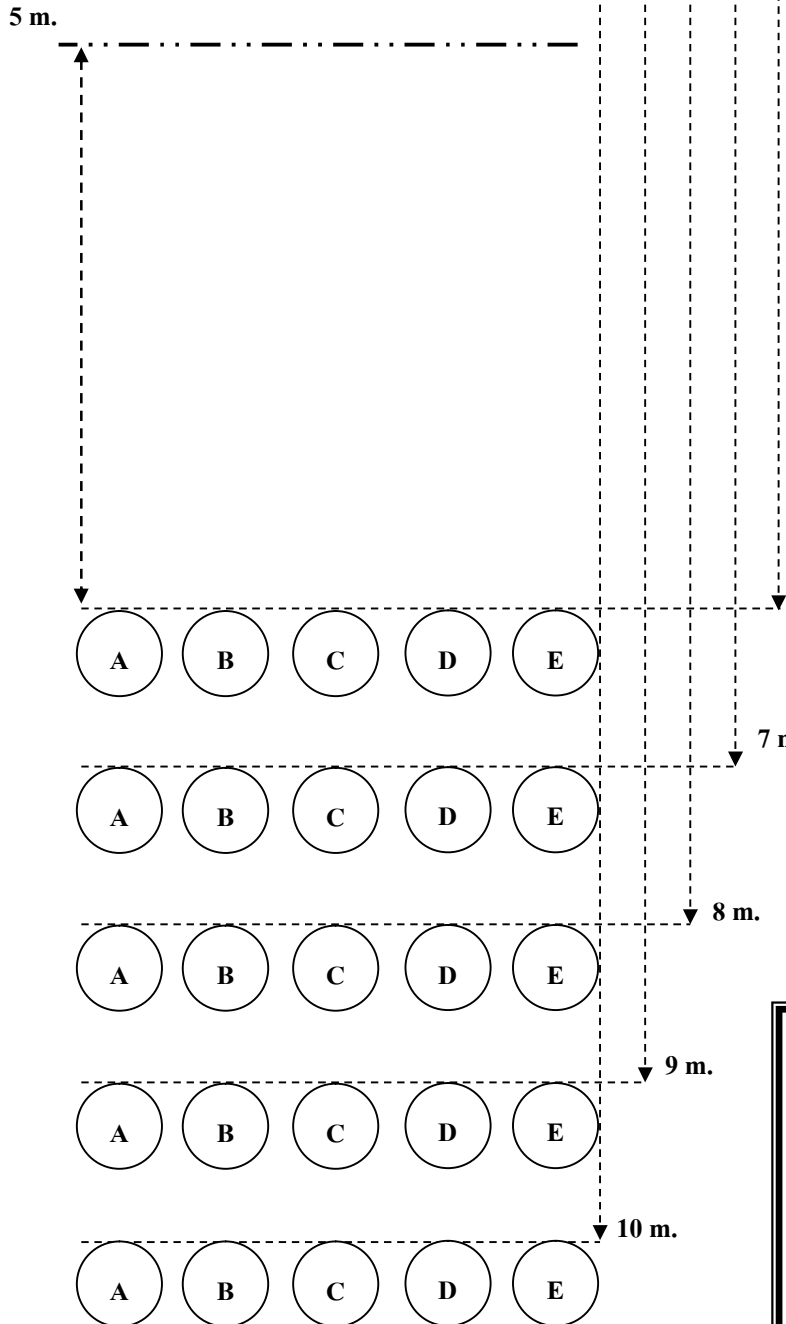
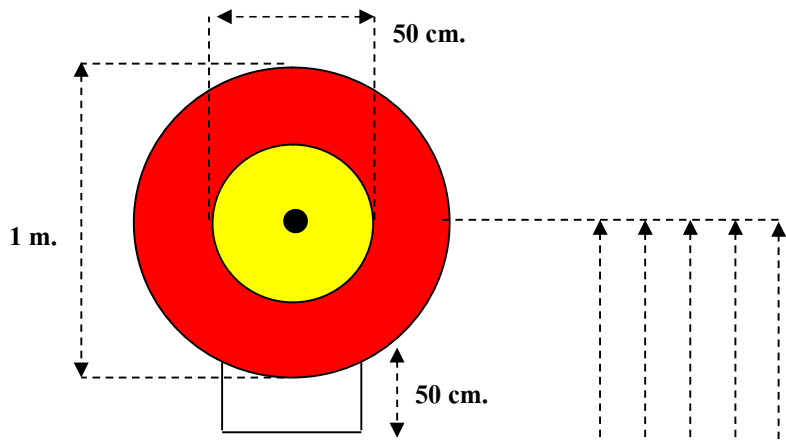

Distance	No.	Score Station				
		A	B	C	D	E
6 m.	1					
	2					
	3					
7 m.	1					
	2					
	3					
8 m.	1					
	2					
	3					
9 m.	1					
	2					
	3					
10 m.	1					
	2					
	3					
Total Score						

Note. This exercise for rehearse lob pattern.
 The player must throw the ball over the line (5m. from the start point) into the yellow circle, using all stations and distances.

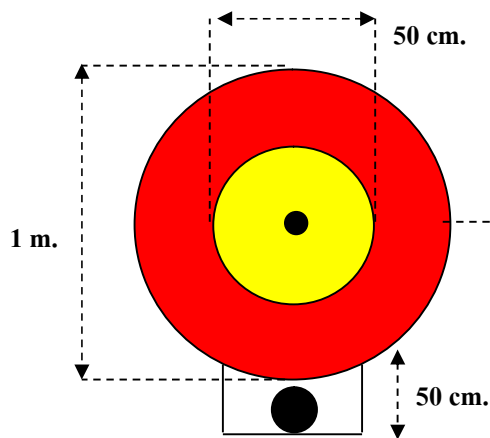

NAME

DATE Total Score.....

Distance	No.	Score Station				
		A	B	C	D	E
6 m.	1					
	2					
	3					
7 m.	1					
	2					
	3					
8 m.	1					
	2					
	3					
9 m.	1					
	2					
	3					
10 m.	1					
	2					
	3					
Total Score						

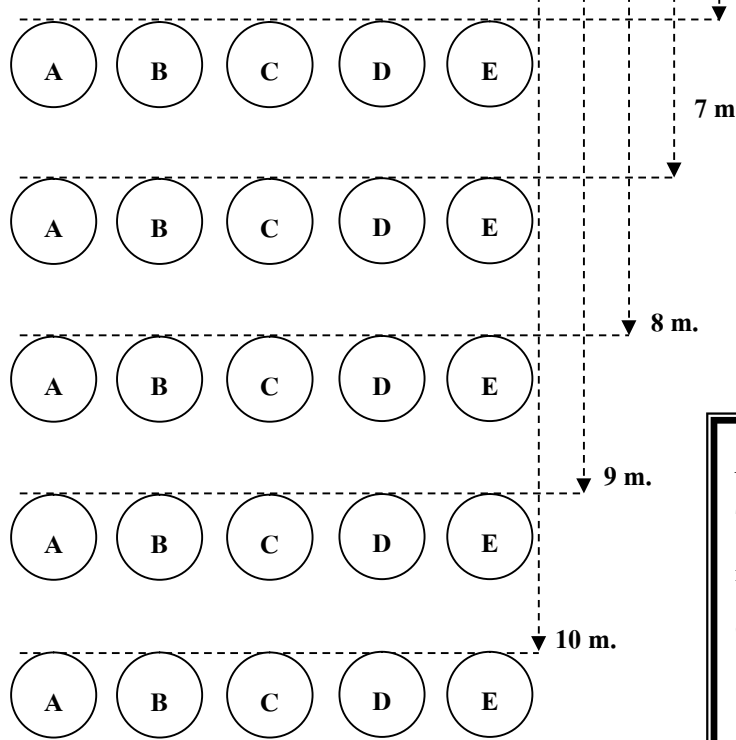

Note.
 The player must throw the ball to the sides (Left or right) to avoid obstacle boules and ending in yellow circle, using all stations and distances.

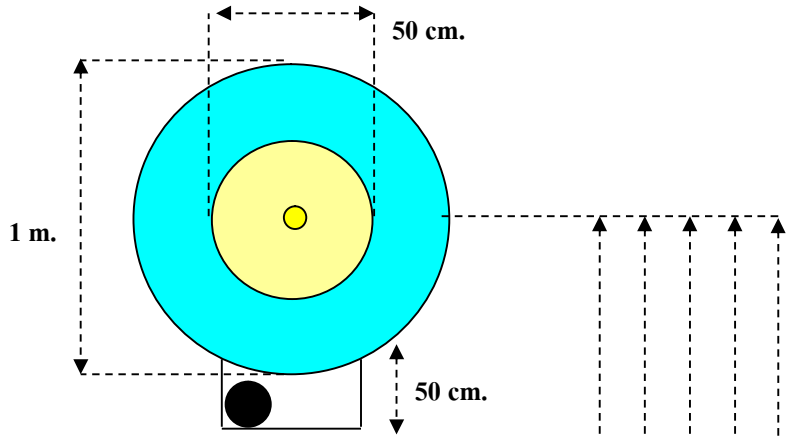

NAME

DATETotal Score.....

Distance	No.	Score Station				
		A	B	C	D	E
6 m.	1					
	2					
	3					
7 m.	1					
	2					
	3					
8 m.	1					
	2					
	3					
9 m.	1					
	2					
	3					
10 m.	1					
	2					
	3					
Total Score						

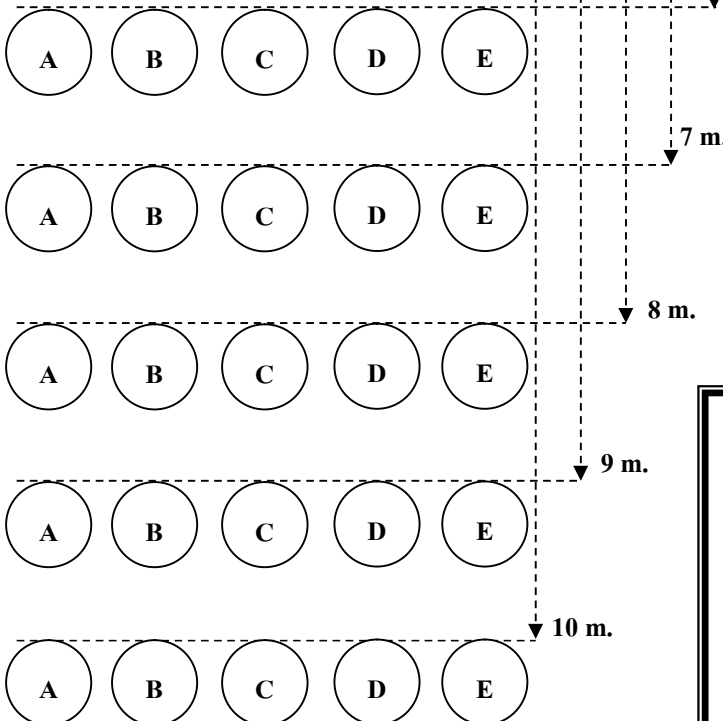

Note.
The player must throw the Boule to the right side to avoid obstacle boules, thrown boules ending in yellow circles, using all stations and distances.

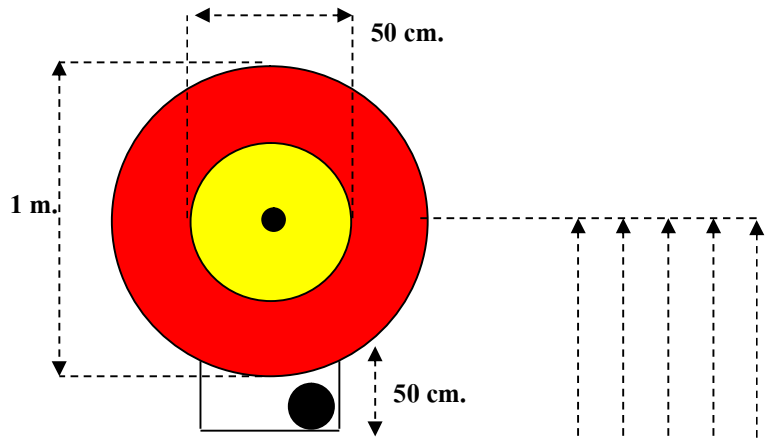

NAME

DATE Total Score.....

Distance	No.	Score Station				
		A	B	C	D	E
6 m.	1					
	2					
	3					
7 m.	1					
	2					
	3					
8 m.	1					
	2					
	3					
9 m.	1					
	2					
	3					
10 m.	1					
	2					
	3					
Total Score						

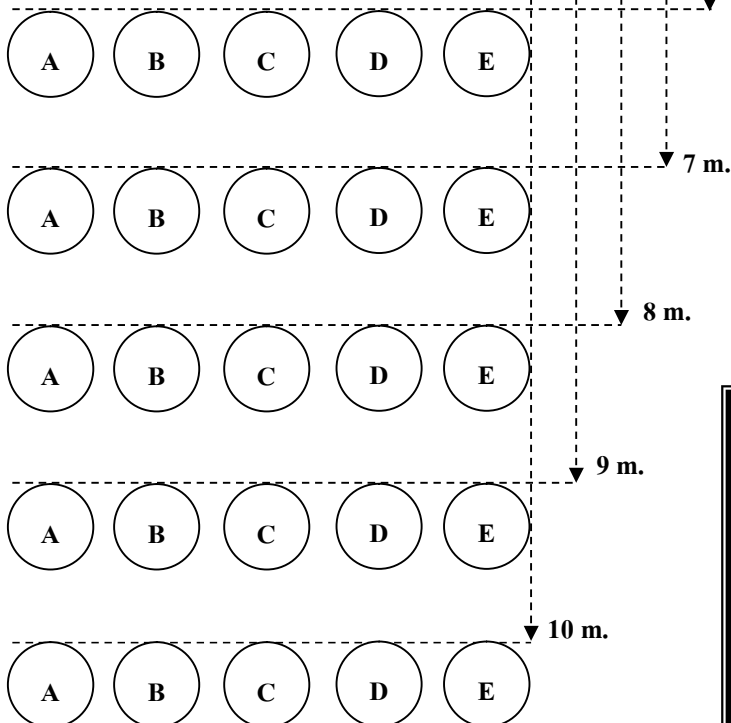

Note.

The player must throw the boules to the left side to avoid obstacle boules and finish in yellow circle, using all stations and distances.

.....

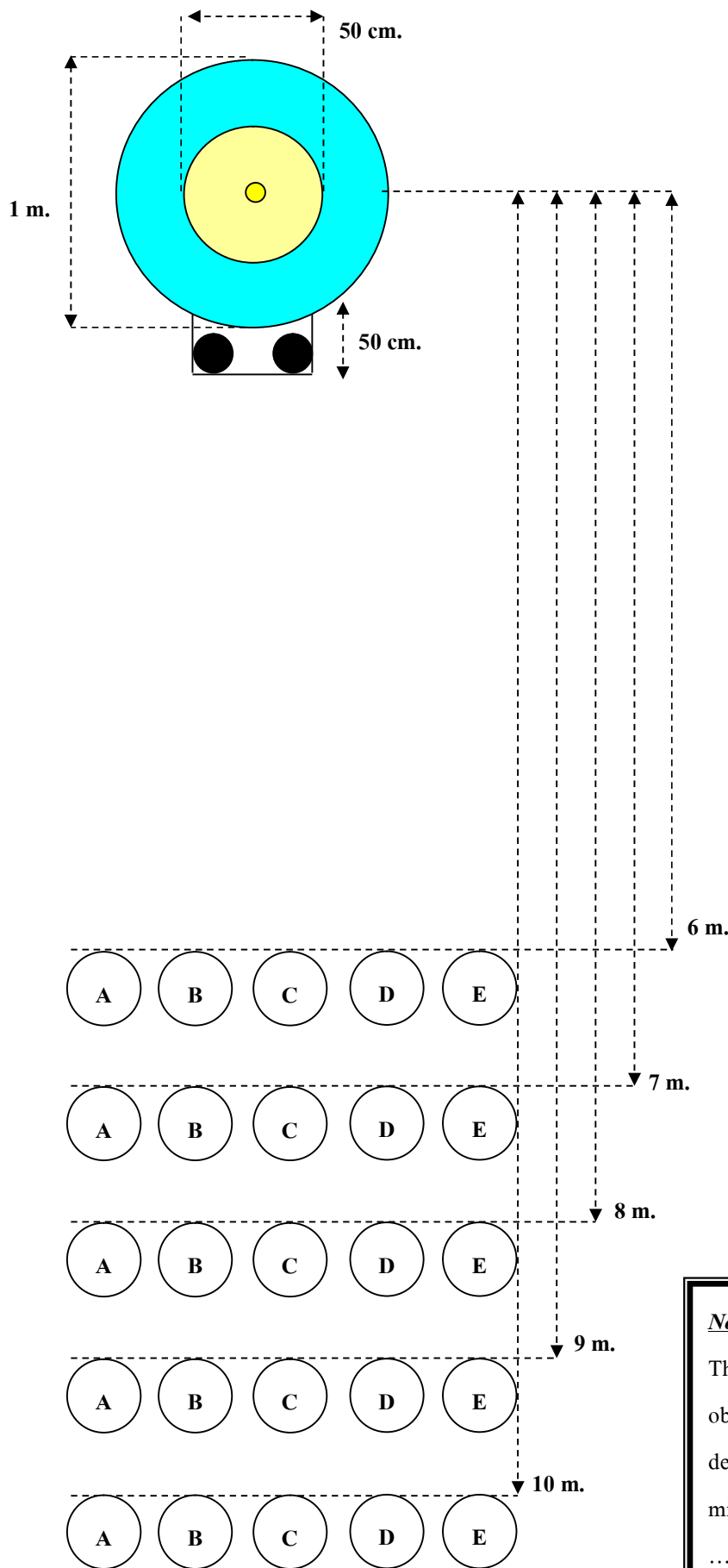

NAME

DATE Total Score.....

Distance	No.	Score Station				
		A	B	C	D	E
6 m.	1					
	2					
	3					
7 m.	1					
	2					
	3					
8 m.	1					
	2					
	3					
9 m.	1					
	2					
	3					
10 m.	1					
	2					
	3					
Total Score						

Note.
 The player must throw the boules to the sides to avoid obstacle boules into the yellow circle. (the player decide to use either the right side, left side or the middle)

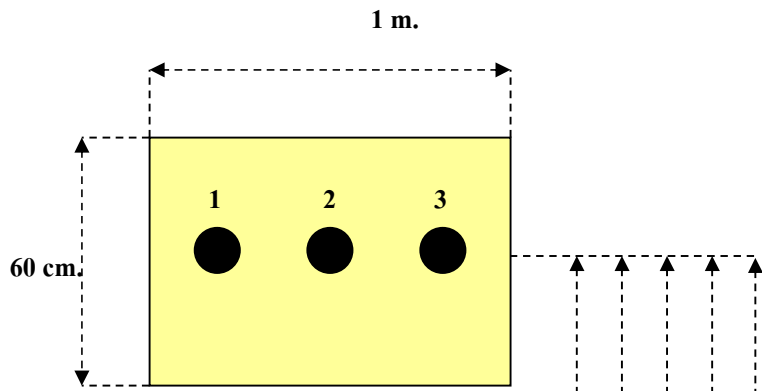

NAME

DATETotal Score.....

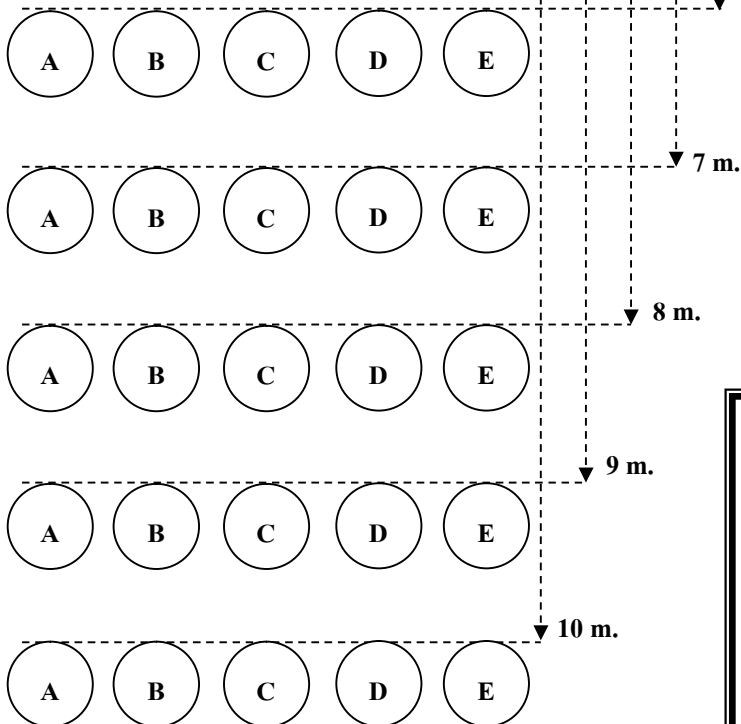

Distance	No.	Score Station				
		A	B	C	D	E
6 m.	1					
	2					
	3					
7 m.	1					
	2					
	3					
8 m.	1					
	2					
	3					
9 m.	1					
	2					
	3					
10 m.	1					
	2					
	3					
Total Score						

Note.
 The player must shoot on the full the black boules to outside the rectangle, using all stations and distances.

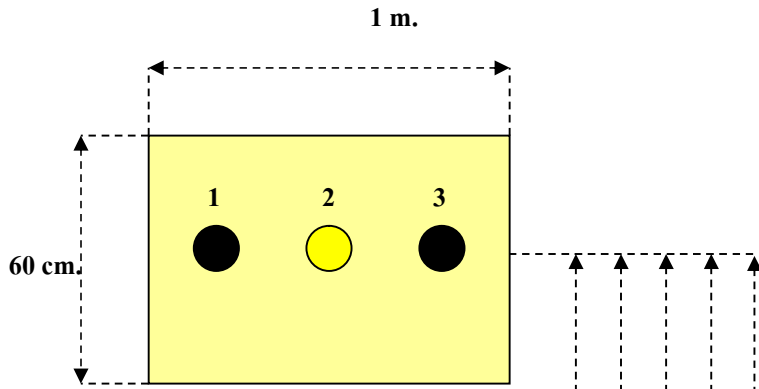

NAME

DATETotal Score.....

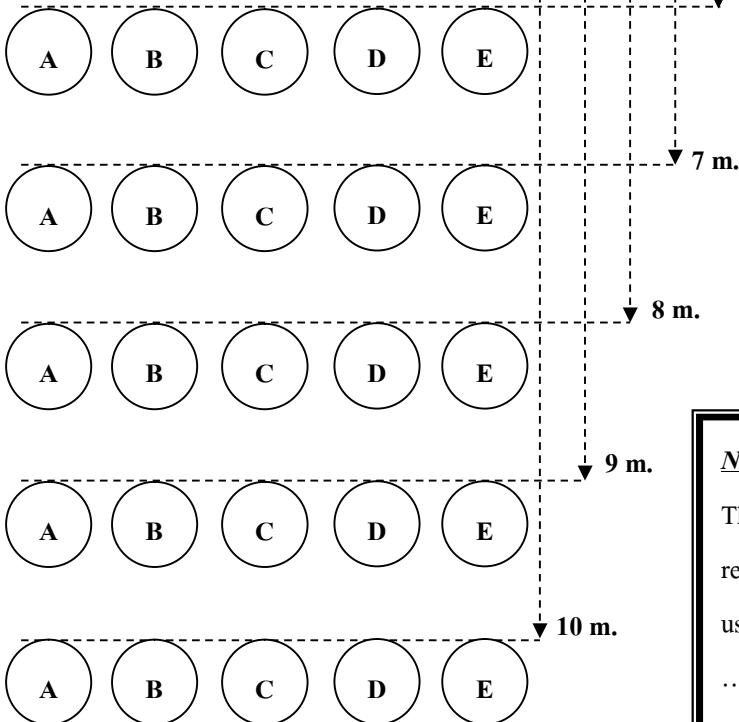

Distance	No.	Score Station				
		A	B	C	D	E
6 m.	1					
	2					
	3					
7 m.	1					
	2					
	3					
8 m.	1					
	2					
	3					
9 m.	1					
	2					
	3					
10 m.	1					
	2					
	3					
Total Score						

Note.
 The player must shoot the yellow boule to leave rectangle then shoot the black boule (no.1 and no. 3) using all stations and distances

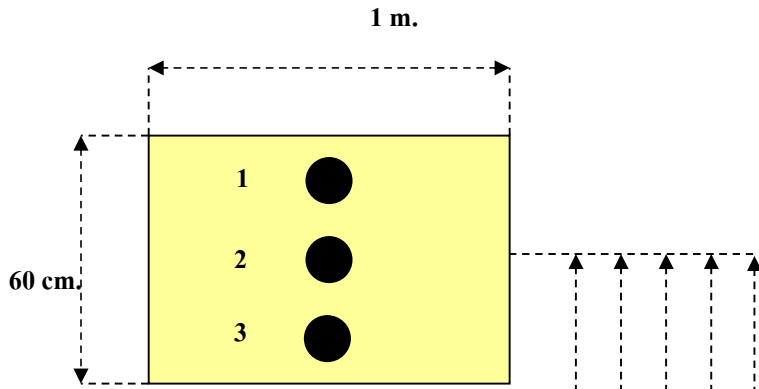

NAME

DATETotal Score.....

Distance	No.	Score Station				
		A	B	C	D	E
6 m.	1					
	2					
	3					
7 m.	1					
	2					
	3					
8 m.	1					
	2					
	3					
9 m.	1					
	2					
	3					
10 m.	1					
	2					
	3					
Total Score						

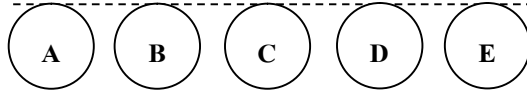
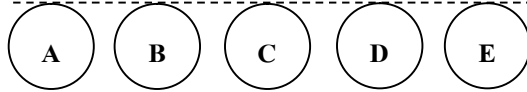
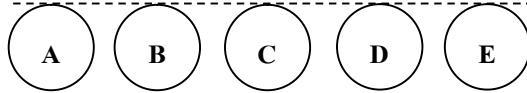
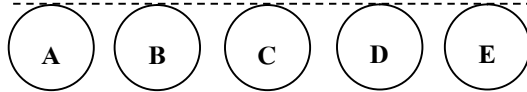
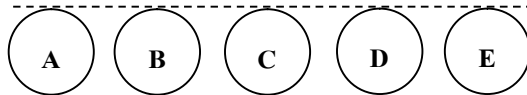

Note.
 The player must shoot the black boules in order 1, 2, 3 so to leave rectangle using all stations and distances.

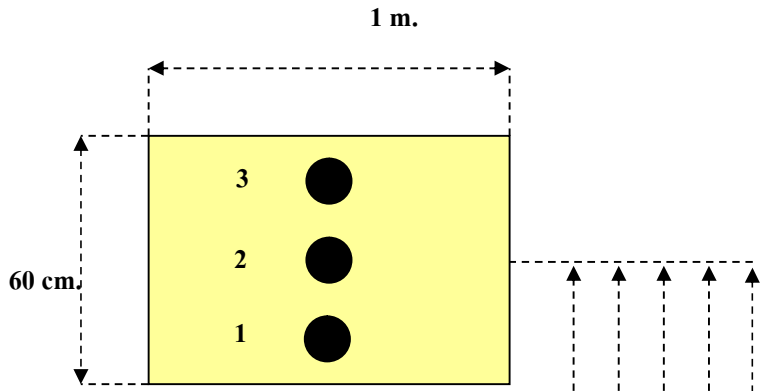

NAME

DATETotal Score.....

Distance	No.	Score Station				
		A	B	C	D	E
6 m.	1					
	2					
	3					
7 m.	1					
	2					
	3					
8 m.	1					
	2					
	3					
9 m.	1					
	2					
	3					
10 m.	1					
	2					
	3					
Total Score						

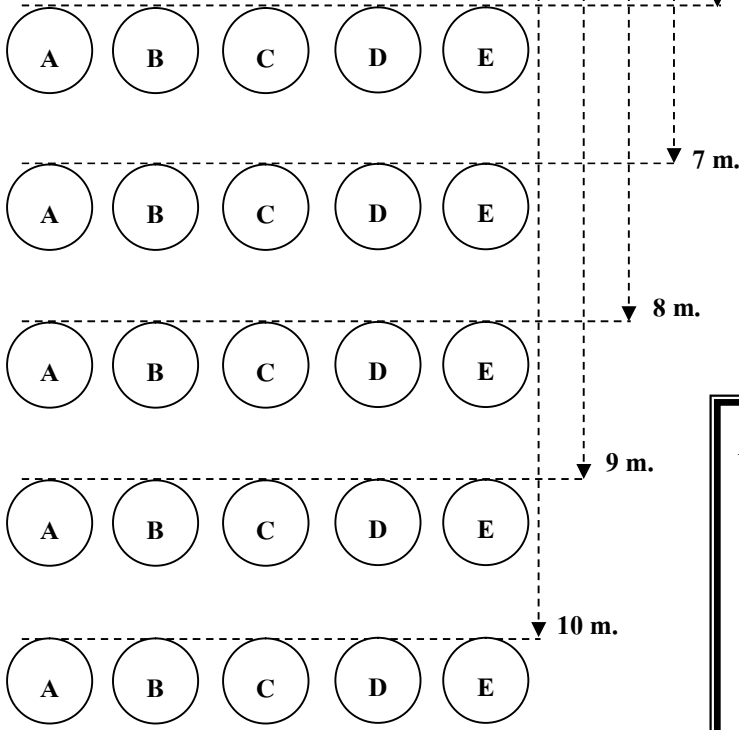

Note.
 The player must shoot the black boules in order 1, 2, 3 so to leave rectangle using all stations and distances.

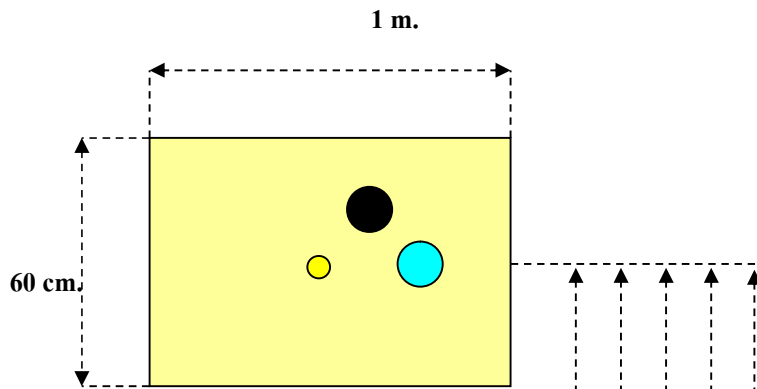

NAME

DATETotal Score.....

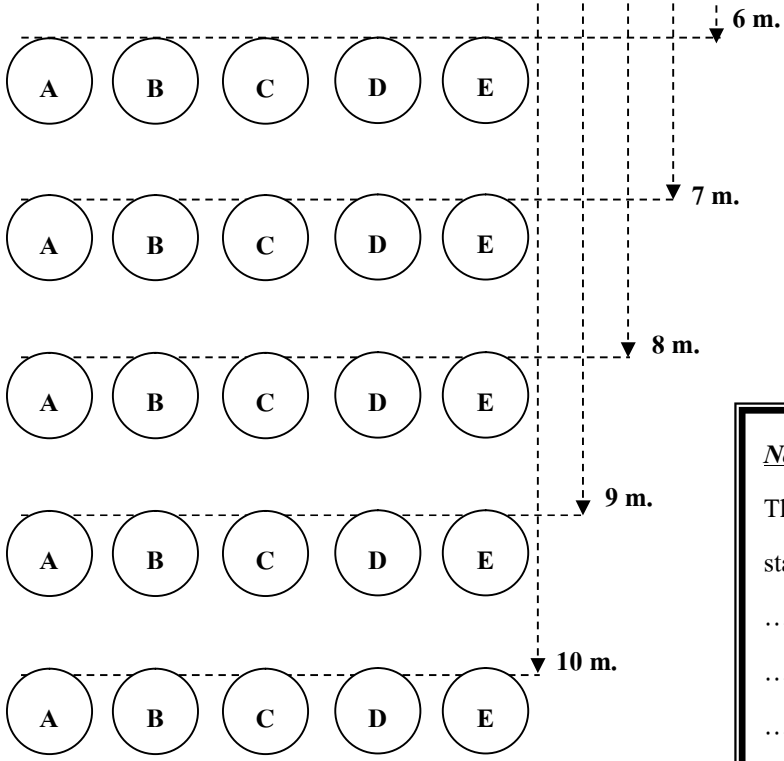

Distance	No.	Score Station				
		A	B	C	D	E
6 m.	1					
	2					
	3					
7 m.	1					
	2					
	3					
8 m.	1					
	2					
	3					
9 m.	1					
	2					
	3					
10 m.	1					
	2					
	3					
Total Score						

Note.
 The player must shoot the black boule only, using all stations and distances.

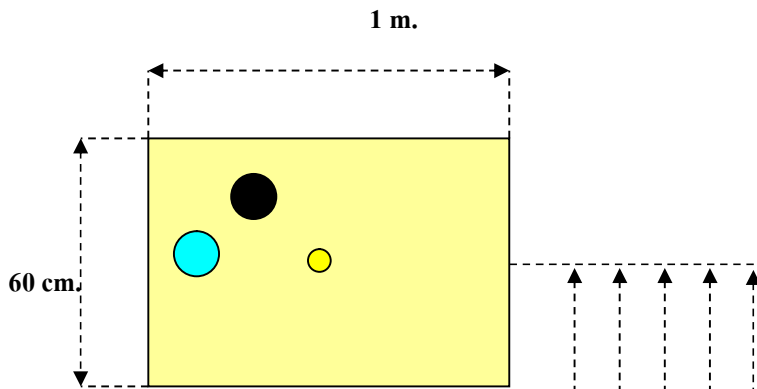

NAME

DATETotal Score.....

Distance	No.	Score Station				
		A	B	C	D	E
6 m.	1					
	2					
	3					
7 m.	1					
	2					
	3					
8 m.	1					
	2					
	3					
9 m.	1					
	2					
	3					
10 m.	1					
	2					
	3					
Total Score						

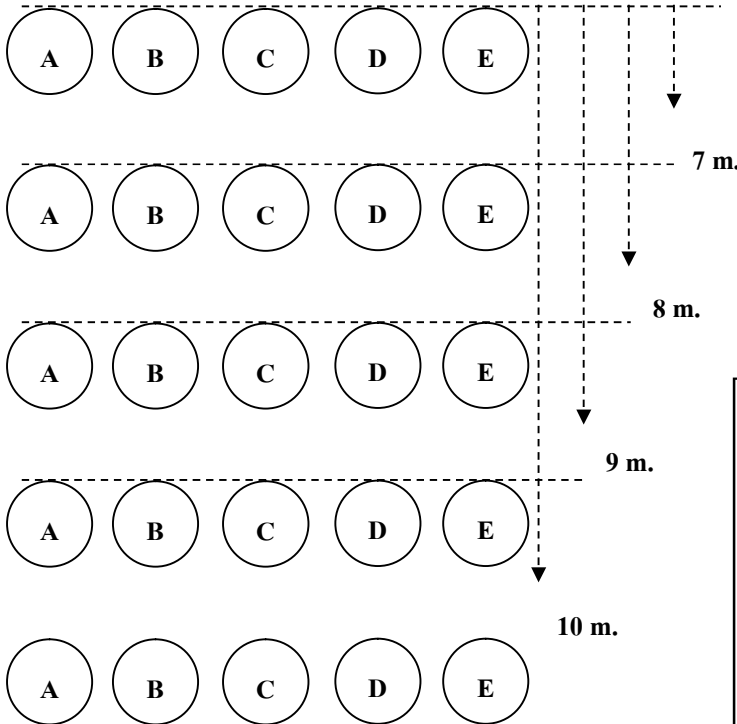

Note.
 The player must shoot the black boules only, using all stations and distances.

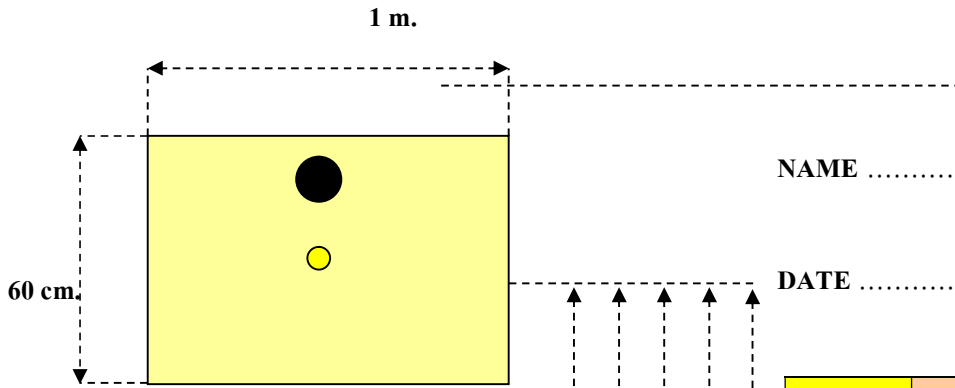

NAME

DATE Total Score.....

Distance	No.	Score Station				
		A	B	C	D	E
6 m.	1					
	2					
	3					
7 m.	1					
	2					
	3					
8 m.	1					
	2					
	3					
9 m.	1					
	2					
	3					
10 m.	1					
	2					
	3					
Total Score						

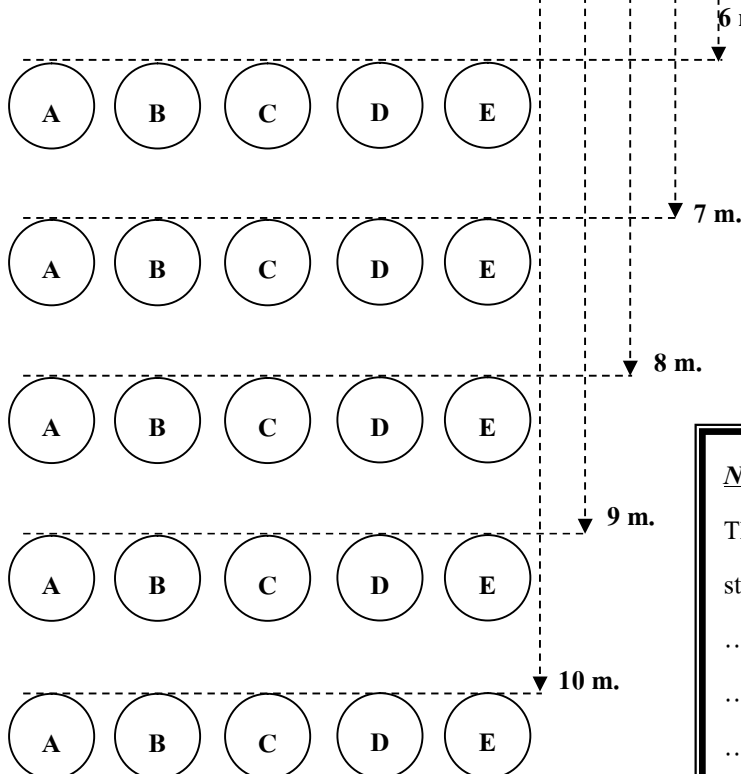

Note.
 The player must shoot the black boule only, using all stations and distances.

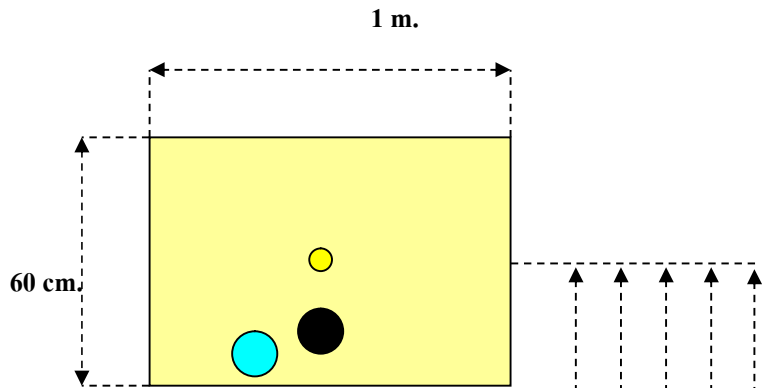

NAME

DATETotal Score.....

Distance	No.	Score Station				
		A	B	C	D	E
6 m.	1					
	2					
	3					
7 m.	1					
	2					
	3					
8 m.	1					
	2					
	3					
9 m.	1					
	2					
	3					
10 m.	1					
	2					
	3					
Total Score						

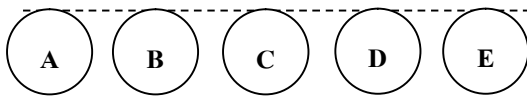
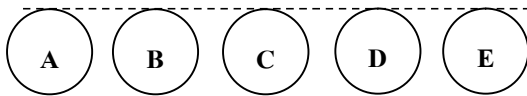
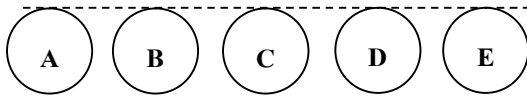
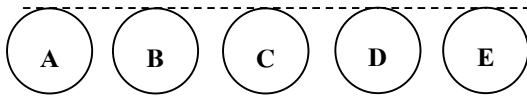
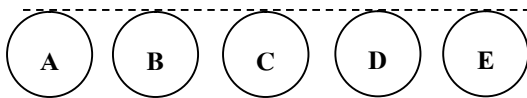

Note.

The player must shoot the black boule only, using all stations and distances.

.....

.....

.....

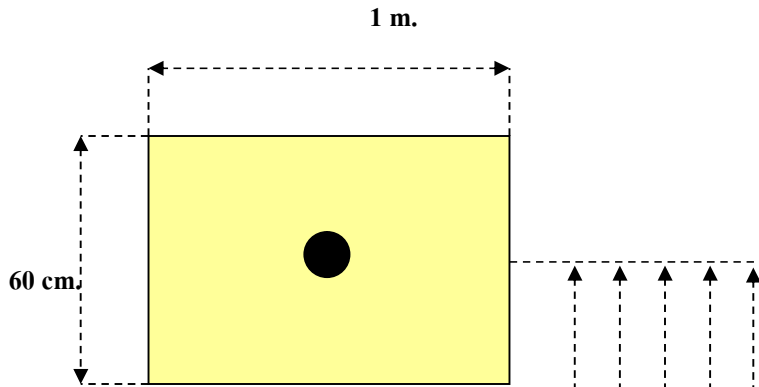

NAME

DATETotal Score.....

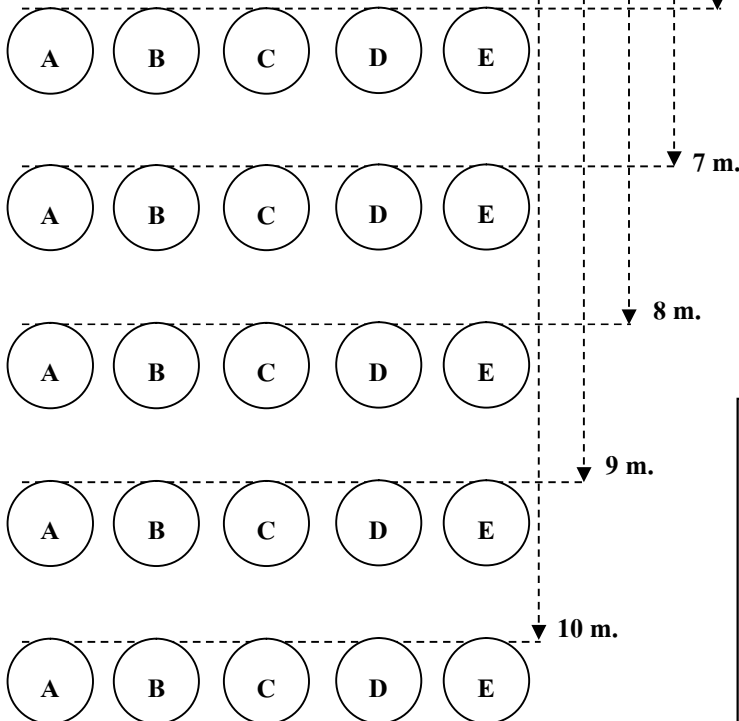

Distance	No.	Score Station				
		A	B	C	D	E
6 m.	1					
	2					
	3					
7 m.	1					
	2					
	3					
8 m.	1					
	2					
	3					
9 m.	1					
	2					
	3					
10 m.	1					
	2					
	3					
Total Score						

Note.
 The player must shoot the black boule only, using all stations and distances.

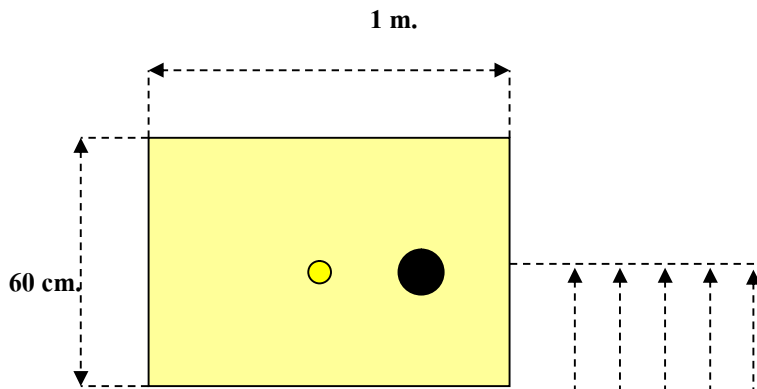

NAME

DATETotal Score.....

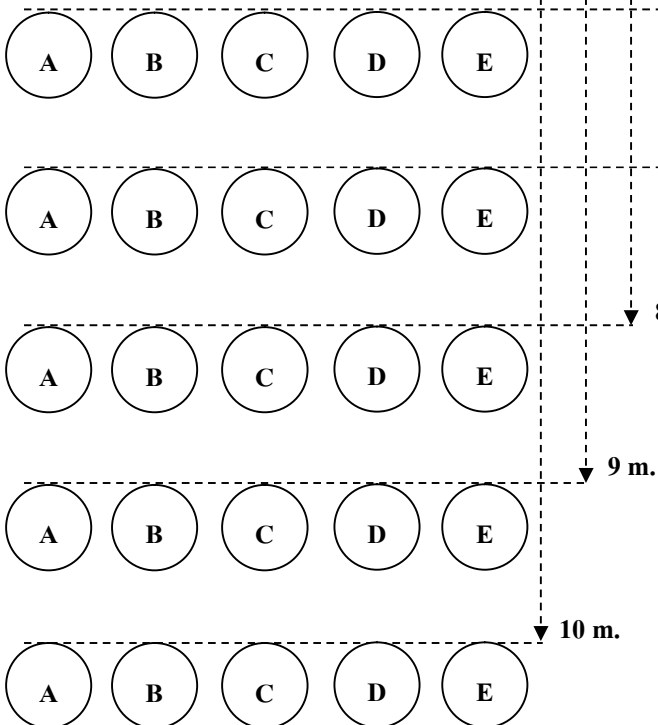

Distance	No.	Score Station				
		A	B	C	D	E
6 m.	1					
	2					
	3					
7 m.	1					
	2					
	3					
8 m.	1					
	2					
	3					
9 m.	1					
	2					
	3					
10 m.	1					
	2					
	3					
Total Score						

Note.
 The player must shoot the black boule only, using all stations and distances.

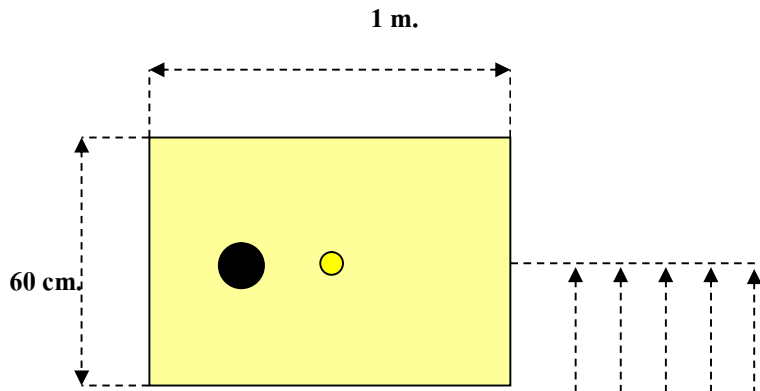

NAME

DATE Total Score.....

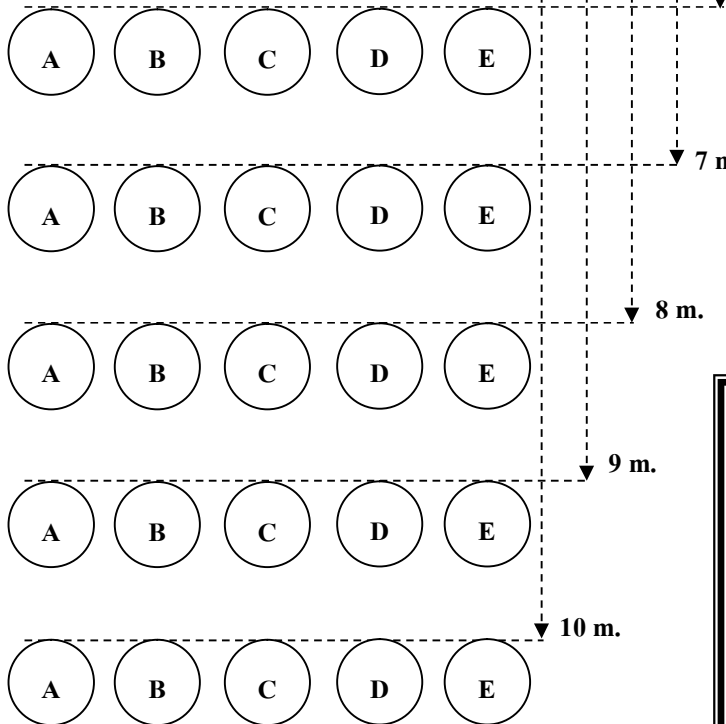

Distance	No.	Score Station				
		A	B	C	D	E
6 m.	1					
	2					
	3					
7 m.	1					
	2					
	3					
8 m.	1					
	2					
	3					
9 m.	1					
	2					
	3					
10 m.	1					
	2					
	3					
Total Score						

Note.

The player must shoot the black boule only, using all stations and distances.

.....

.....

.....

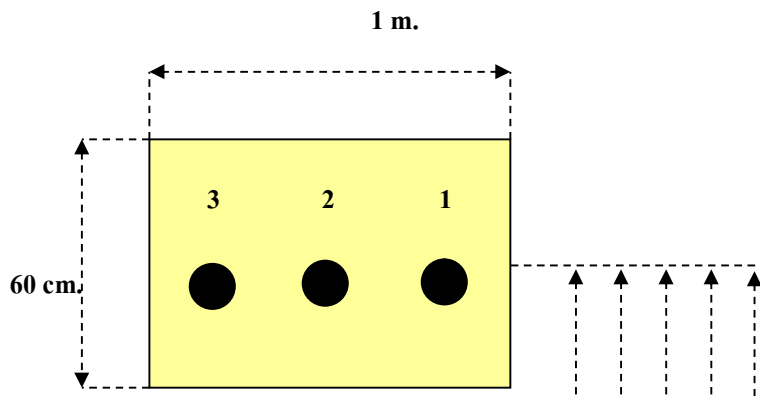

NAME

DATETotal Score.....

Distance	No.	Score Station				
		A	B	C	D	E
6 m.	1					
	2					
	3					
7 m.	1					
	2					
	3					
8 m.	1					
	2					
	3					
9 m.	1					
	2					
	3					
10 m.	1					
	2					
	3					
Total Score						

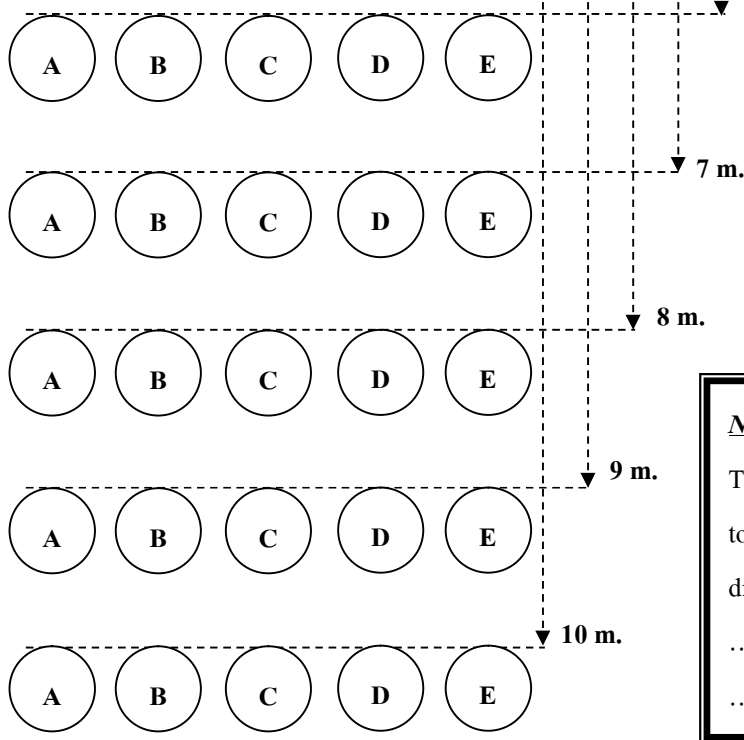

Note.
 The player must shoot in order 1, 2, 3 the black boules to go to outside the rectangle, using all stations and distances.

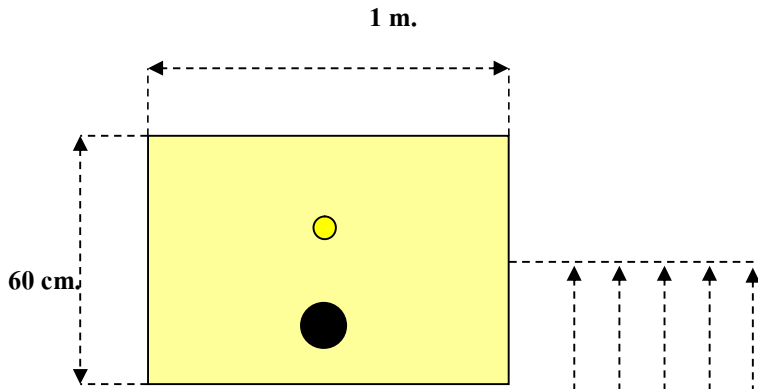

NAME

DATETotal Score.....

Distance	No.	Score Station				
		A	B	C	D	E
6 m.	1					
	2					
	3					
7 m.	1					
	2					
	3					
8 m.	1					
	2					
	3					
9 m.	1					
	2					
	3					
10 m.	1					
	2					
	3					
Total Score						

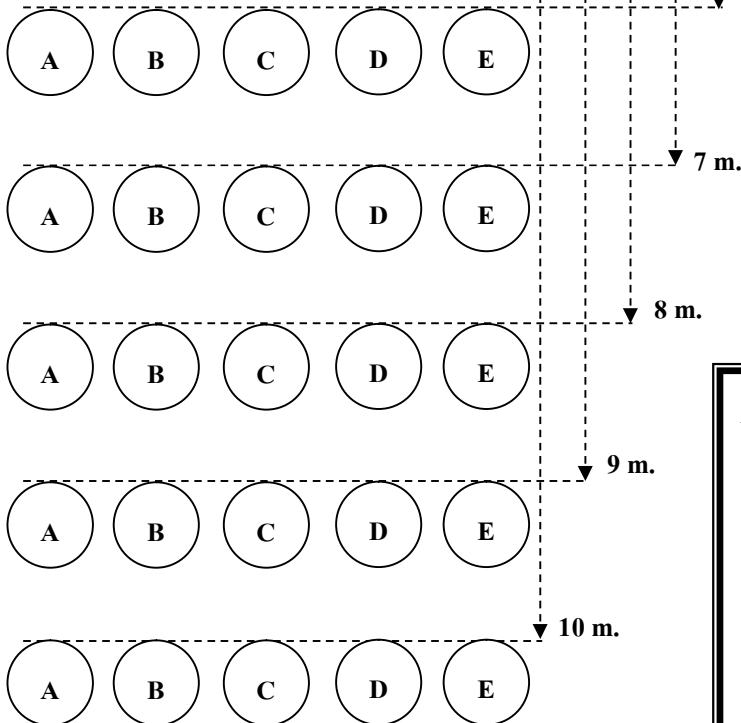

Note.
 The player must shoot the black boule only, using all stations and distances.

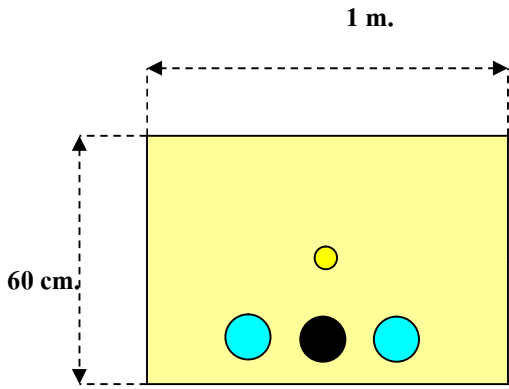

NAME

DATETotal Score.....

Distance	No.	Score Station				
		A	B	C	D	E
6 m.	1					
	2					
	3					
7 m.	1					
	2					
	3					
8 m.	1					
	2					
	3					
9 m.	1					
	2					
	3					
10 m.	1					
	2					
	3					
Total Score						

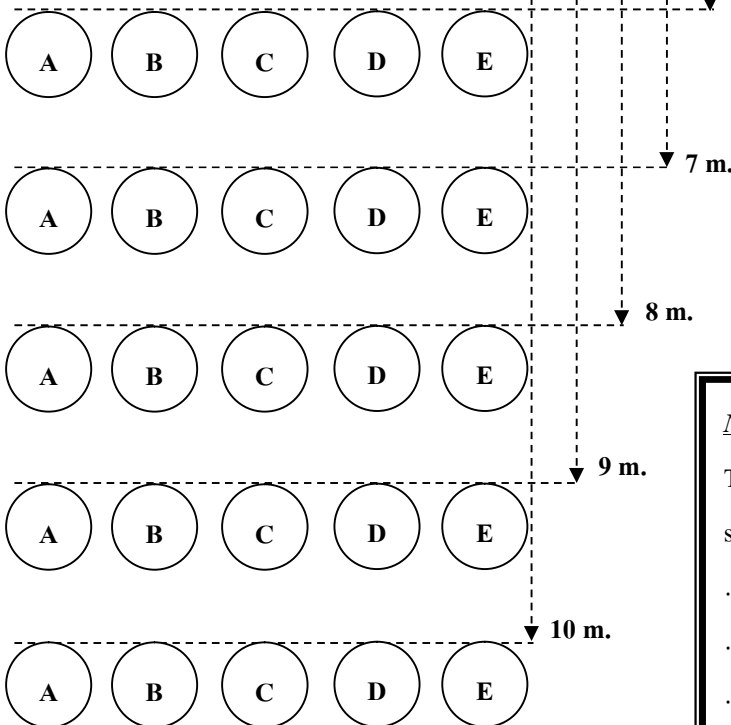

Note.
 The player must shoot the black boule only, using all stations and distances.

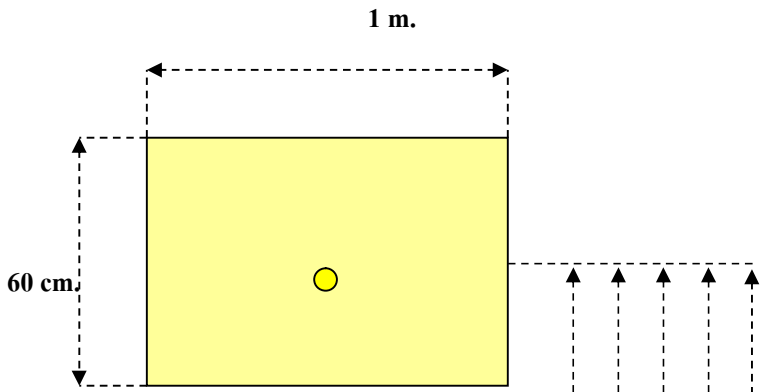

NAME

DATETotal Score.....

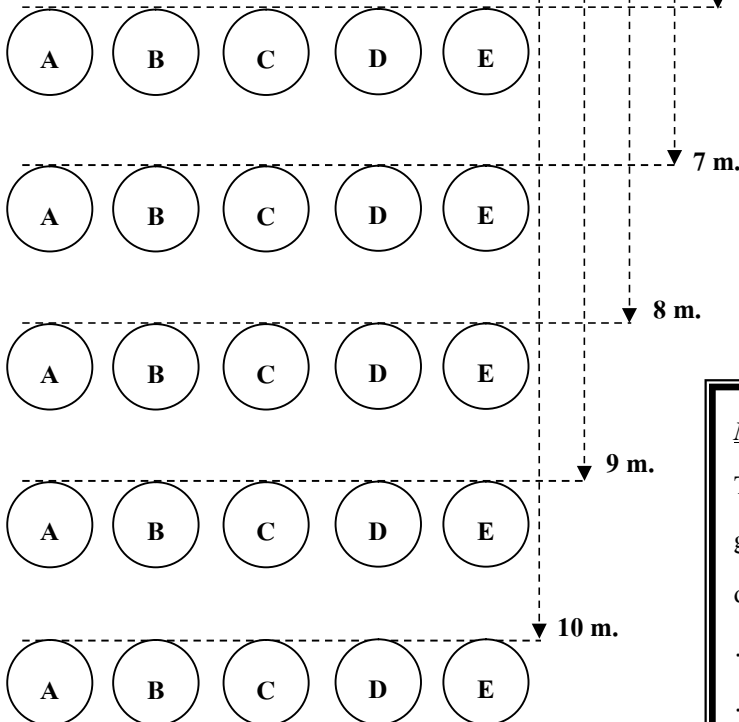

Distance	No.	Score Station				
		A	B	C	D	E
6 m.	1					
	2					
	3					
7 m.	1					
	2					
	3					
8 m.	1					
	2					
	3					
9 m.	1					
	2					
	3					
10 m.	1					
	2					
	3					
Total Score						

Note.
 The player must shoot the jack only and the jack must go outside the rectangle using all stations and distances.

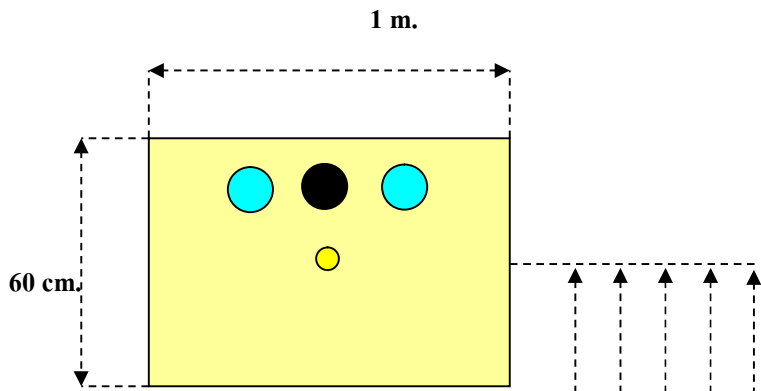

NAME

DATETotal Score.....

Distance	No.	Score Station				
		A	B	C	D	E
6 m.	1					
	2					
	3					
7 m.	1					
	2					
	3					
8 m.	1					
	2					
	3					
9 m.	1					
	2					
	3					
10 m.	1					
	2					
	3					
Total Score						

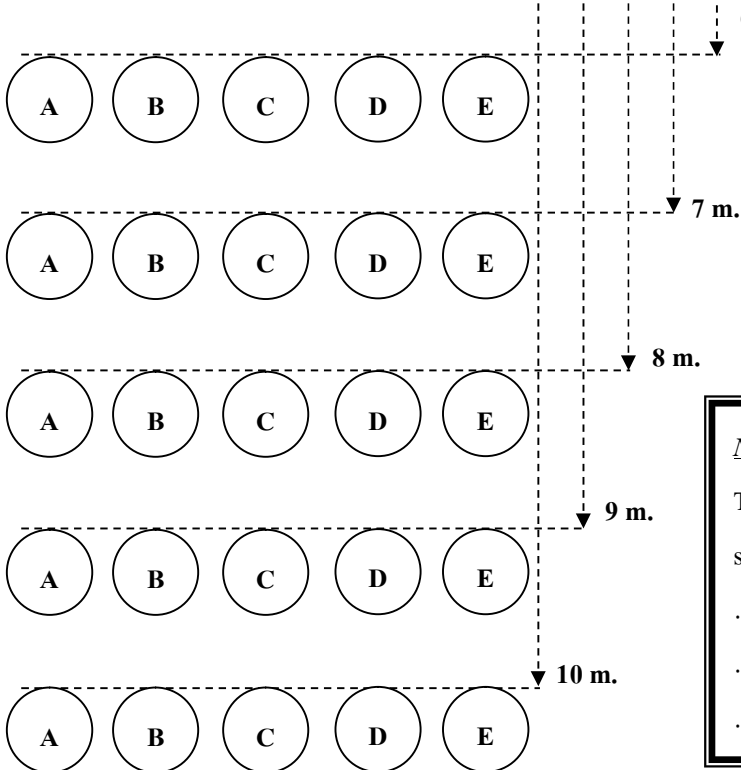

Note.
 The player must shoot the black boule only, using all stations and distances.

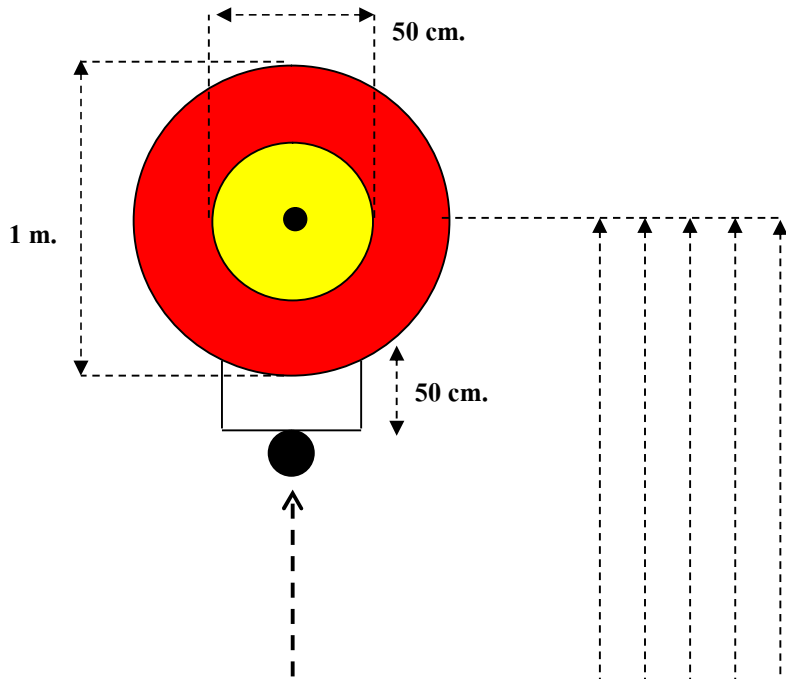

NAME

DATETotal Score.....

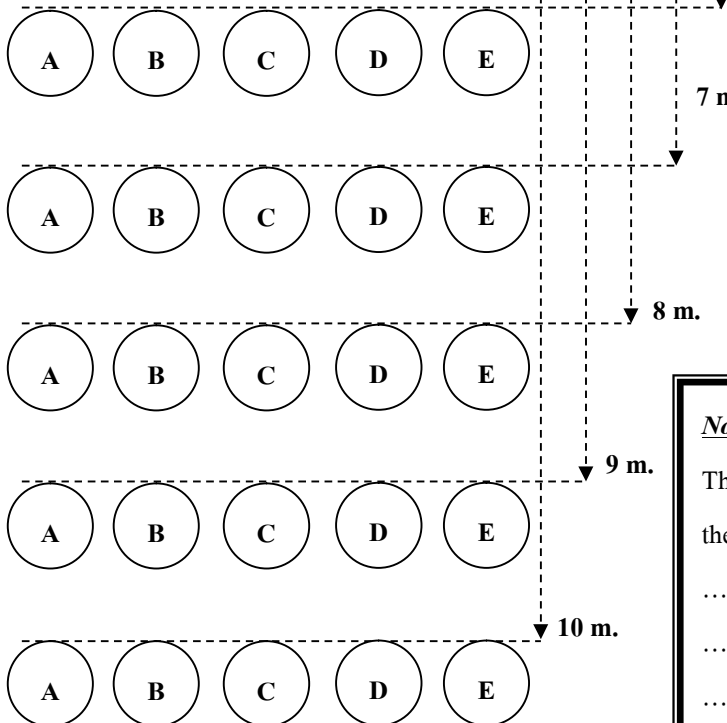

Distance	No.	Score Station				
		A	B	C	D	E
6 m.	1					
	2					
	3					
7 m.	1					
	2					
	3					
8 m.	1					
	2					
	3					
9 m.	1					
	2					
	3					
10 m.	1					
	2					
	3					
Total Score						

Note.
 The player must to promote the black boules to inside the circle for 2 points, using all stations and distances.

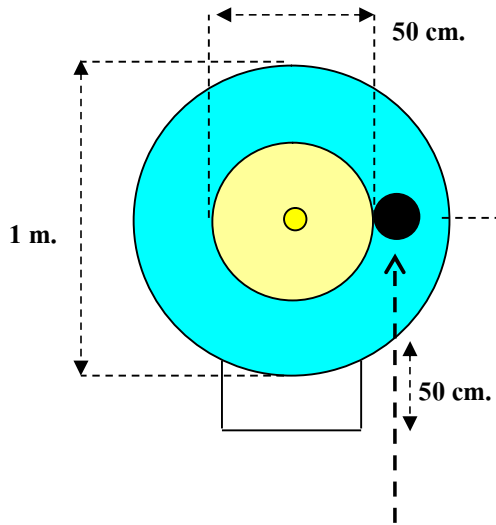

NAME

DATE Total Score.....

Distance	No.	Score Station				
		A	B	C	D	E
6 m.	1					
	2					
	3					
7 m.	1					
	2					
	3					
8 m.	1					
	2					
	3					
6 m. 9 m.	1					
	2					
	3					
10 m.	1					
	2					
	3					
Total Score						

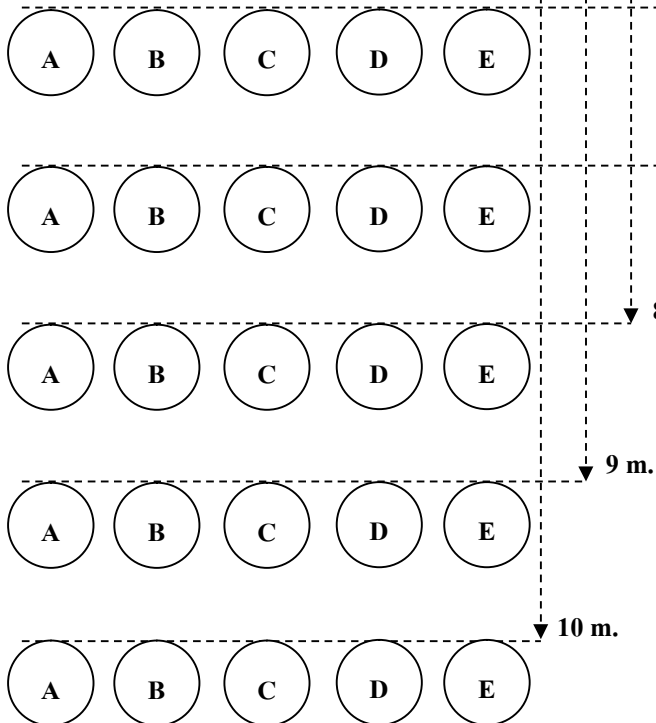

Note.
 The player must move the black boules to outside of the circle, using all stations and distances.

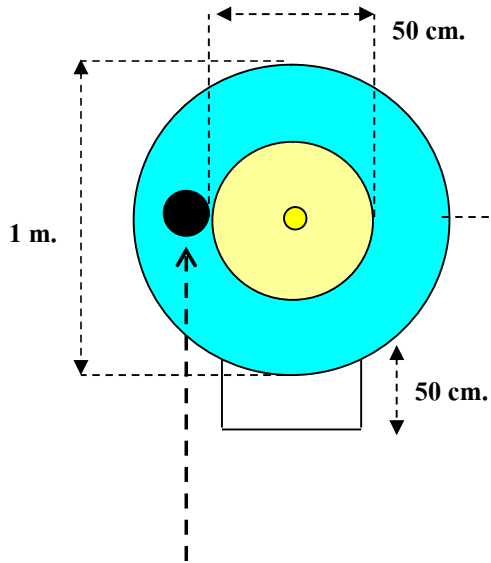

NAME

DATE Total Score.....

Distance	No.	Score Station				
		A	B	C	D	E
6 m.	1					
	2					
	3					
7 m.	1					
	2					
	3					
8 m.	1					
	2					
	3					
9 m.	1					
	2					
	3					
10 m.	1					
	2					
	3					
Total Score						

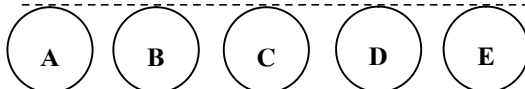

7 m.

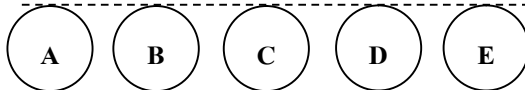

8 m.

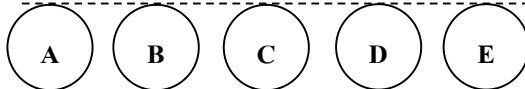

9 m.

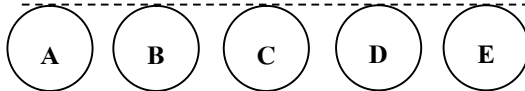

10 m.

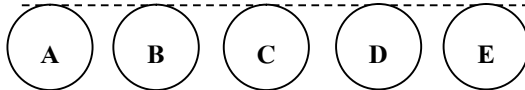

Note.
 The player must move the black boule to outside of the circle, using all stations and distances.

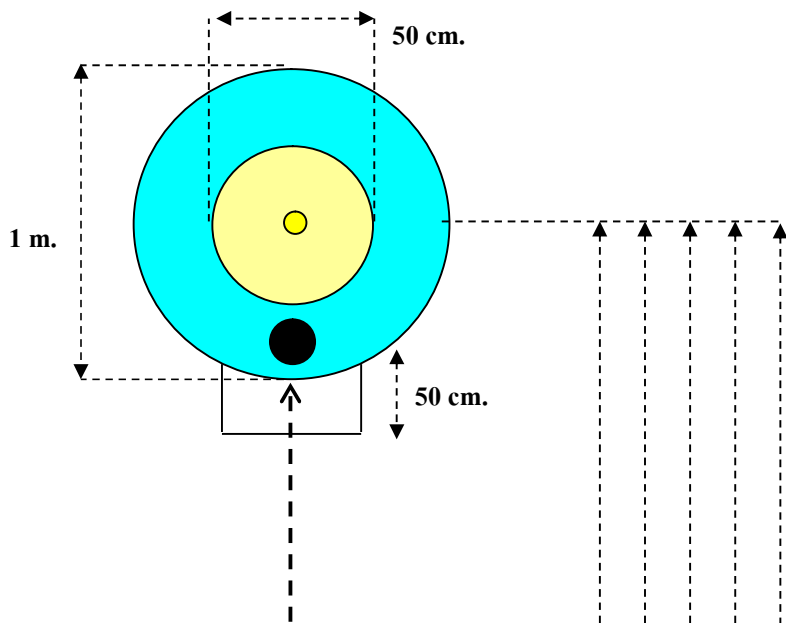

NAME

DATE Total Score.....

Distance	No.	Score Station				
		A	B	C	D	E
6 m.	1					
	2					
	3					
7 m.	1					
	2					
	3					
8 m.	1					
	2					
	3					
6 m. 9 m.	1					
	2					
	3					
10 m.	1					
	2					
	3					
Total Score						

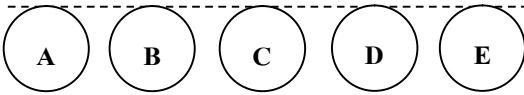
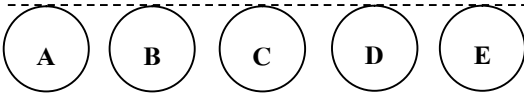
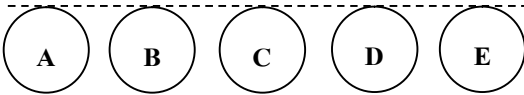
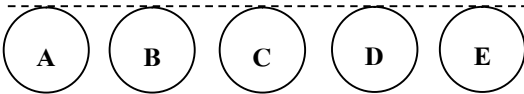
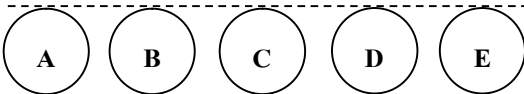

Note.
 The player must move the black boules outside of the circle, using all stations and distances.

SHOOTING

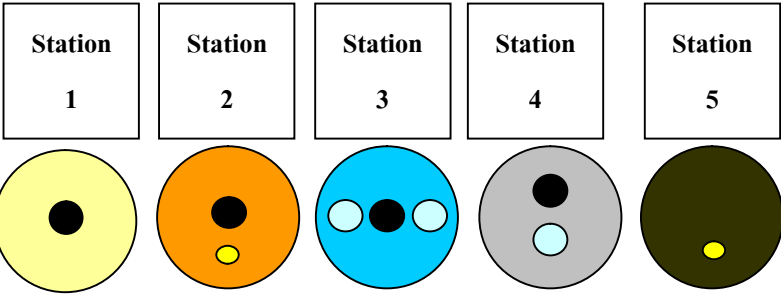

NAME

DATE Total Score.....

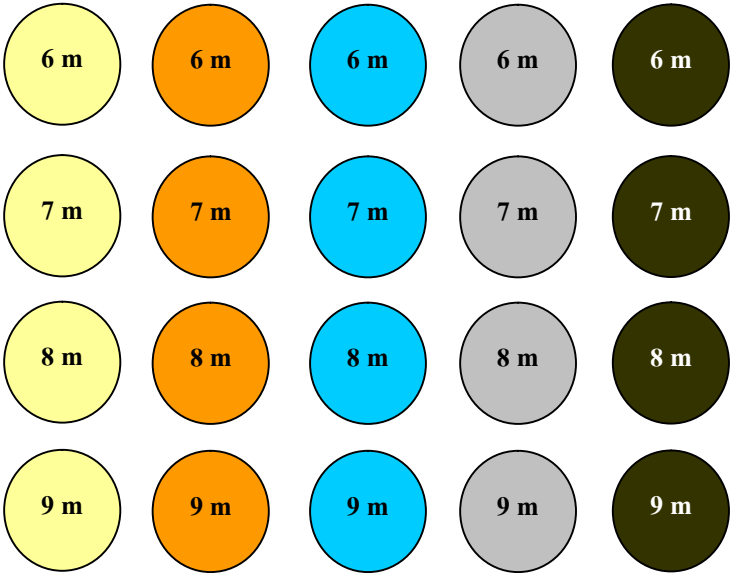

Station	Distance	Score			
		5	3	1	0
1	6 m.				
	7 m.				
	8 m.				
	9 m.				
2	6 m.				
	7 m.				
	8 m.				
	9 m.				
3	6 m.				
	7 m.				
	8 m.				
	9 m.				
4	6 m.				
	7 m.				
	8 m.				
	9 m.				
5	6 m.				
	7 m.				
	8 m.				
	9 m.				
	Total Score				

Training Report

For **PLAYER**

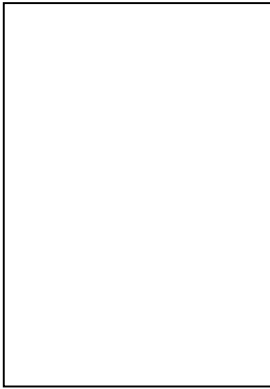

Name.....

Position.....

Photo